

# User Manual

## 3KW, 2.5KWh PORTABLE ENERGY BANK

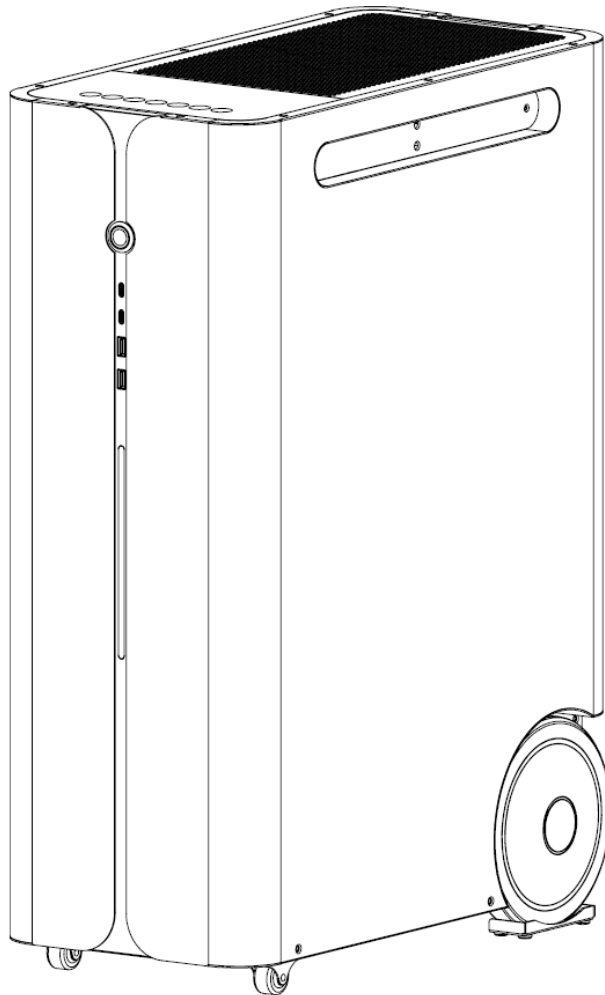

Version: 1.0

# Table Of Contents

<b>ABOUT THIS MANUAL .....</b>	<b>1</b>
Purpose.....	1
Scope.....	1
<b>SAFETY INSTRUCTIONS.....</b>	<b>1</b>
<b>INTRODUCTION .....</b>	<b>2</b>
Basic System Architecture .....	2
<b>PRODUCT OVERVIEW.....</b>	<b>3</b>
Main Unit.....	3
External Battery Module (Purchased separately) .....	5
<b>INSTALLATION .....</b>	<b>6</b>
Package Contents.....	6
Preparation .....	6
Internal Battery Connection .....	7
AC Input Connection.....	7
PV Connection .....	8
AC Output Connection.....	9
USB Charger.....	10
Parallel Function .....	11
<b>OPERATION.....</b>	<b>15</b>
Power ON/OFF .....	15
Operation and Display Panel .....	15
Pages Information.....	16
Configurations.....	18
Wi-Fi Connection .....	19
Prioritizing Energies Scenarios.....	20
<b>CLEARANCE AND MAINTENANCE FOR ANTI-DUST KIT .....</b>	<b>23</b>
Overview .....	23
Clearance and Maintenance.....	23
<b>SPECIFICATIONS .....</b>	<b>24</b>
<b>TROUBLE SHOOTING .....</b>	<b>25</b>
<b>Appendix I: The Wi-Fi Operation Guide.....</b>	<b>27</b>

# ABOUT THIS MANUAL

## Purpose

This manual describes the assembly, installation, operation and troubleshooting of this unit. Please read this manual carefully before installations and operations. Keep this manual for future reference.

## Scope

This manual provides safety and installation guidelines as well as information on tools and wiring.

## SAFETY INSTRUCTIONS



**WARNING: This chapter contains important safety and operating instructions. Read and keep this manual for future reference.**

1. Before using the unit, read all instructions and cautionary markings on the unit, the batteries and all appropriate sections of this manual.
2. Do not disassemble the unit. Take it to a qualified service center when service or repair is required. Incorrect re-assembly may result in a risk of electric shock or fire.
3. To reduce risk of electric shock, disconnect all wirings before attempting any maintenance or cleaning. Turning off the unit will not reduce this risk.
4. **CAUTION** – Only qualified personnel can install this device with battery.
5. NEVER cause AC output and DC input short circuited. Do NOT connect to the mains when DC input short circuits.
6. **Warning!!** Only qualified service persons are able to service this device. If errors still persist after following troubleshooting table, please send this inverter/charger back to local dealer or service center for maintenance.
7. **WARNING:** Because this inverter is non-isolated, only three types of PV modules are acceptable: single crystalline, poly crystalline with class A-rated and CIGS modules. To avoid any malfunction, do not connect any PV modules with possible current leakage to the inverter. For example, grounded PV modules will cause current leakage to the inverter. When using CIGS modules, please be sure NO grounding.
8. **CAUTION:** It's requested to use PV junction box with surge protection. Otherwise, it will cause damage on inverter when lightning occurs on PV modules.

## INTRODUCTION

This is a portable energy bank for home and adventure. The power stations have a battery, inverter and smart charging technology all built into a neat plug and play unit. Plug and Play off-grid system provides multiple charging options, giving you the flexibility to charge from AC (wall outlet or generator) and solar panel. All units are provided multiple power sockets and USB charger ports, allowing to power your diverse electronic devices.

## Basic System Architecture

The following illustration shows basic application for this inverter/charger. It also includes following devices to have a complete running system:

- Generator or Utility.
- PV modules

Consult with your system integrator for other possible system architectures depending on your requirements.

This inverter can power all kinds of appliances in home or office environment, including motor-type appliances such as tube light, fan, refrigerator and air conditioner.

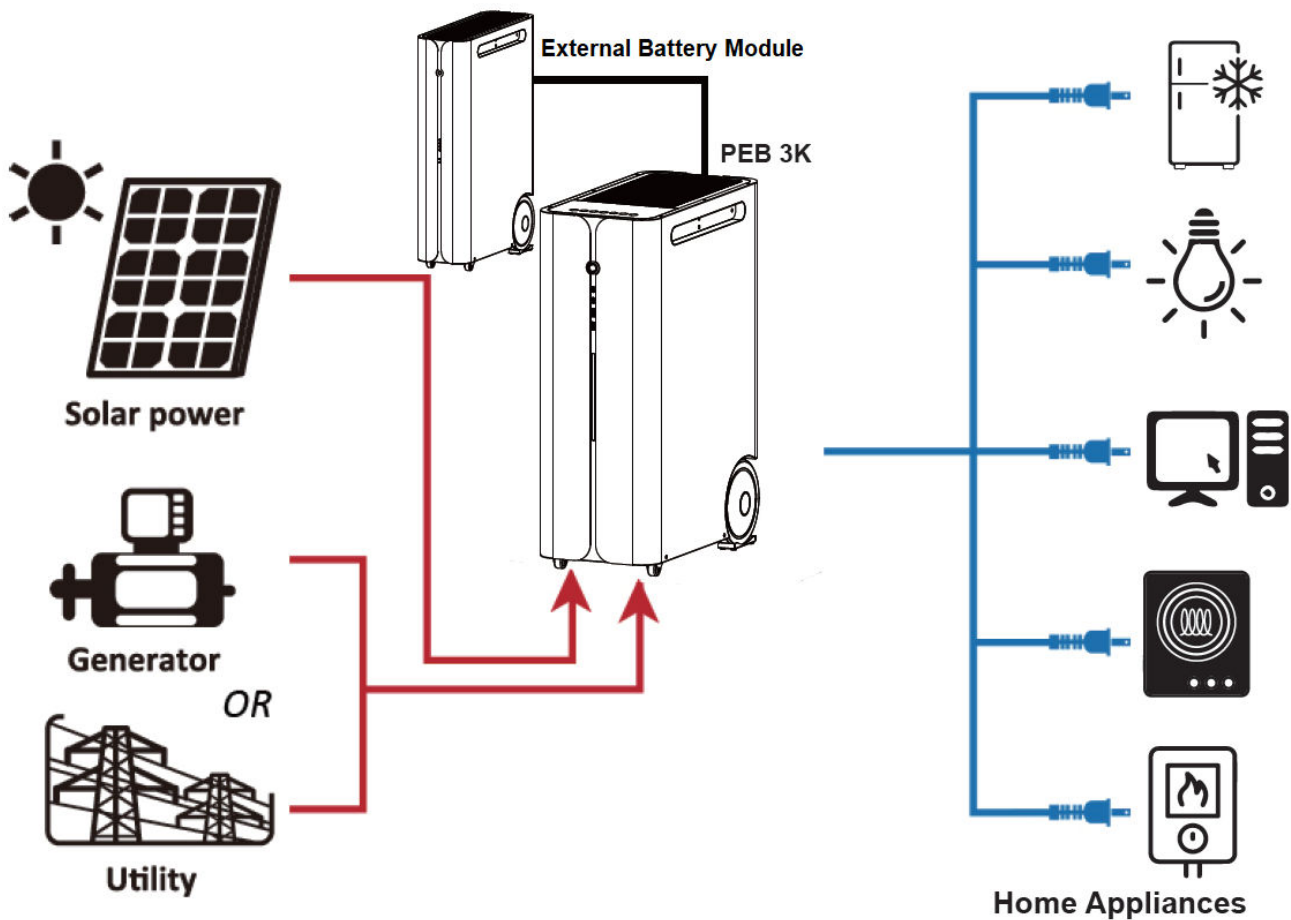
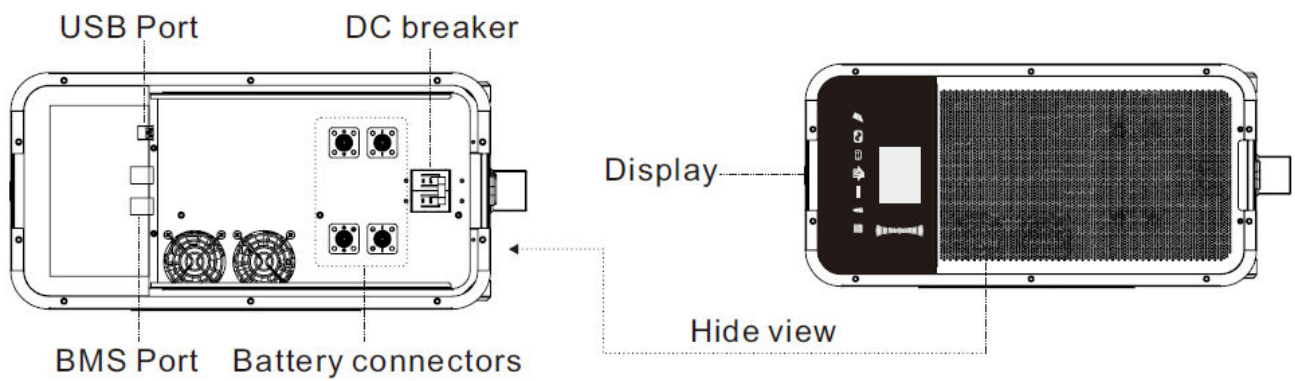
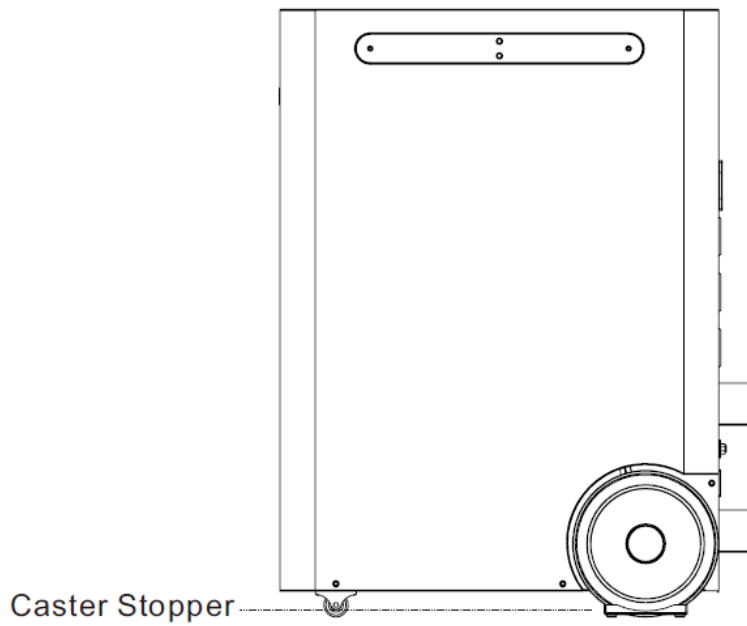
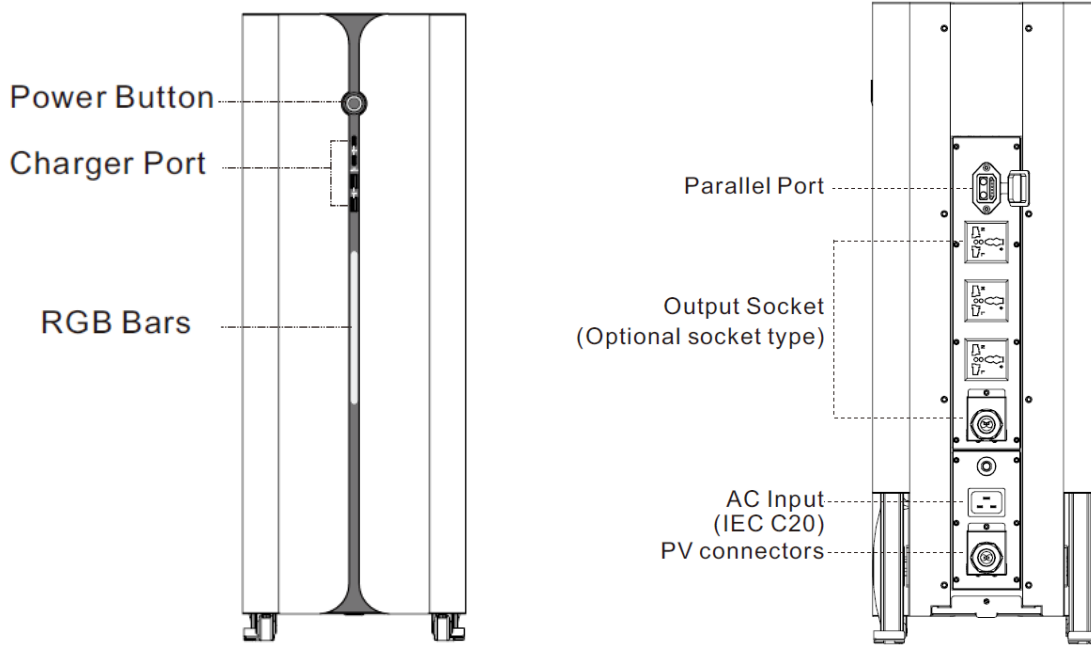

Figure 1 Energy Storage System

# PRODUCT OVERVIEW

## Main Unit



# Optional receptacles

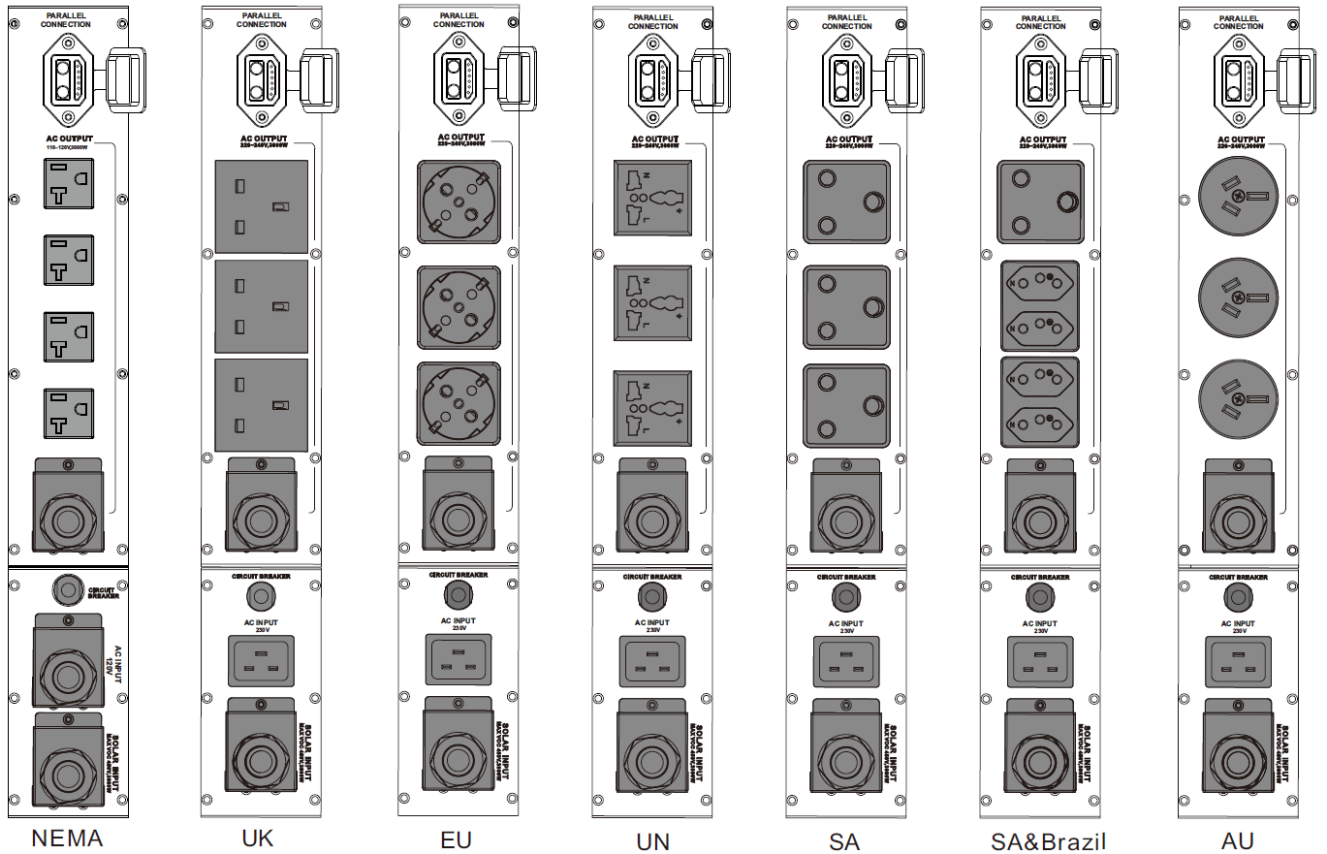

# External Battery Module (Purchased separately)

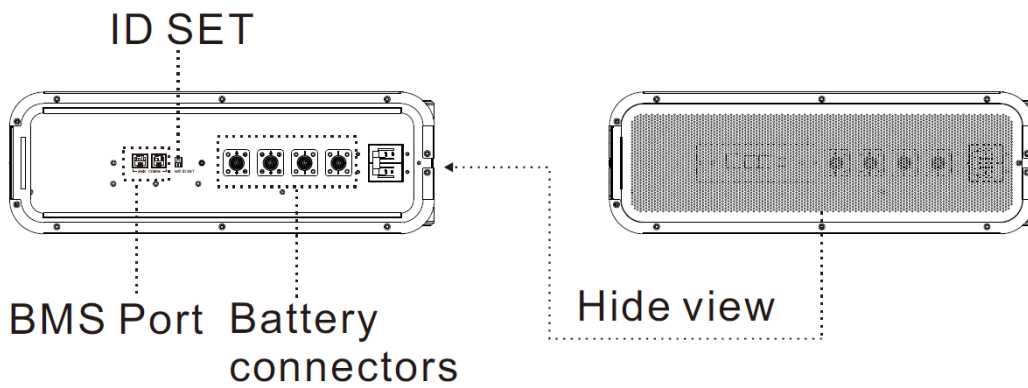
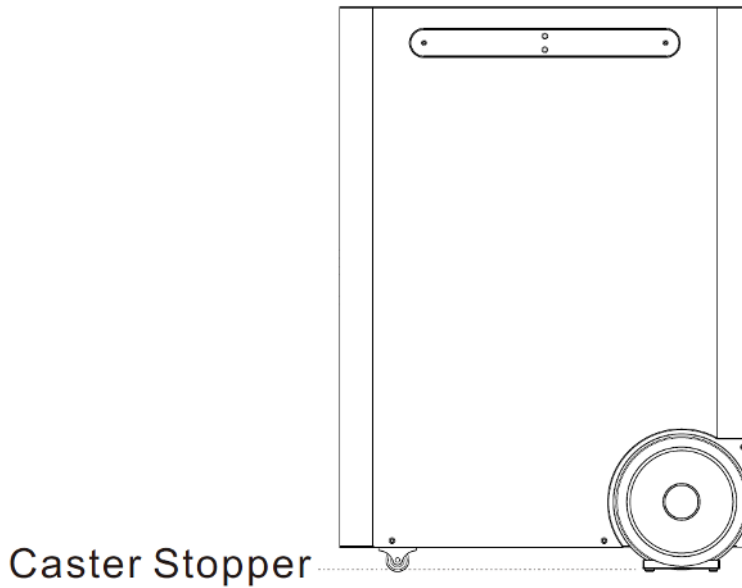
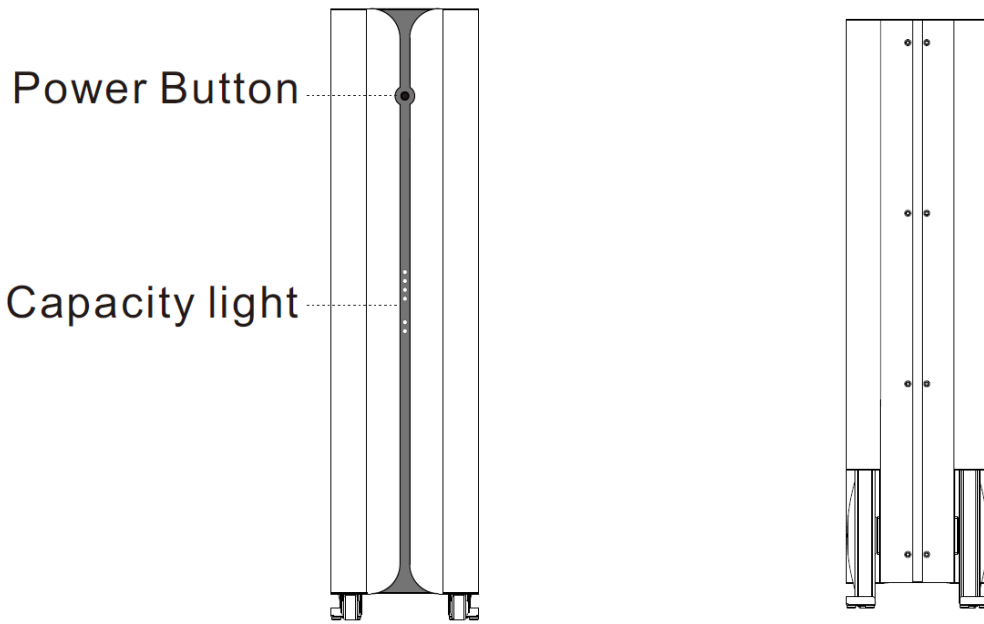

# INSTALLATION

## Package Contents

Before installation, please inspect the content. Be sure that nothing inside the package is damaged. You should have received the following items inside the package:

 Inverter with built-in battery	 Manual	 AC power cord
	 Cable Gland x 2	 Caster stopper x 2

Optional kit:

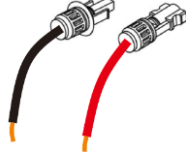
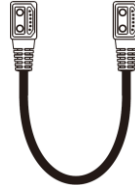
 PV connector	 PV connector with cable	 Parallel Cable
--	---	---

## Preparation

Before operation, it's recommended to install the caster stoppers to enhance the stability.

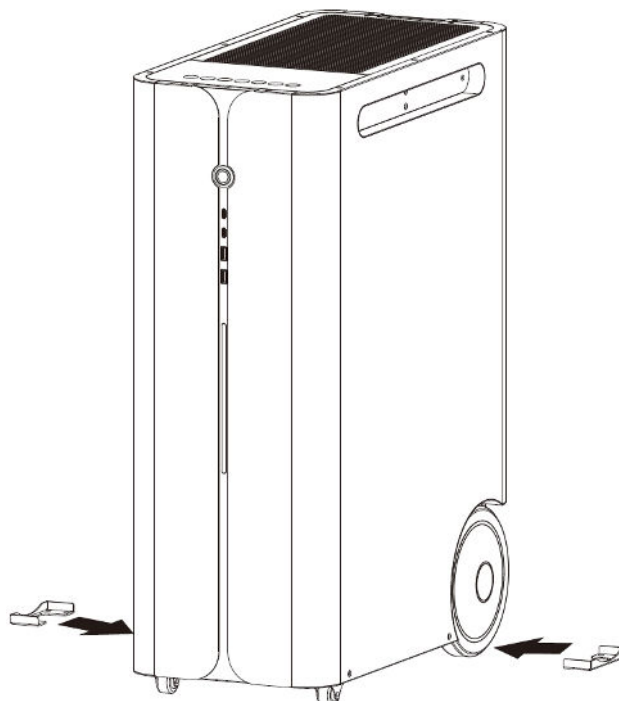



## Internal Battery Connection

For safety concern, the internal battery is disconnected from the internal DC breaker before shipment.

Before installation, please remove two screws from the top panel and turn on the internal DC breaker. Then, fix those screws firmly.

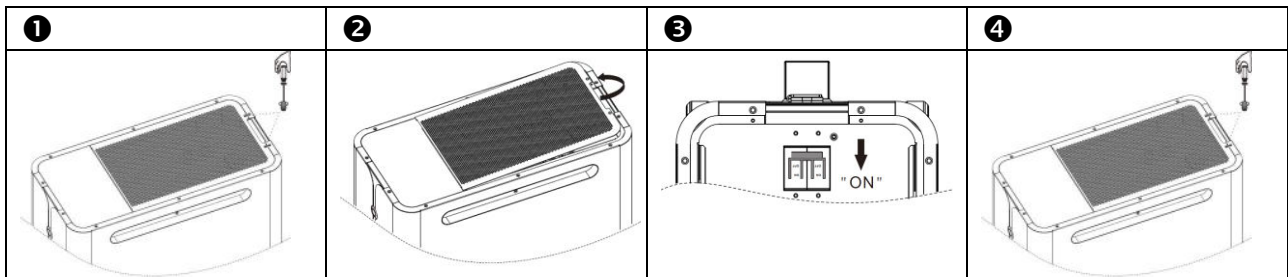

## AC Input Connection

Connect the AC power cord to the IEC Inlet and then plug it into utility.

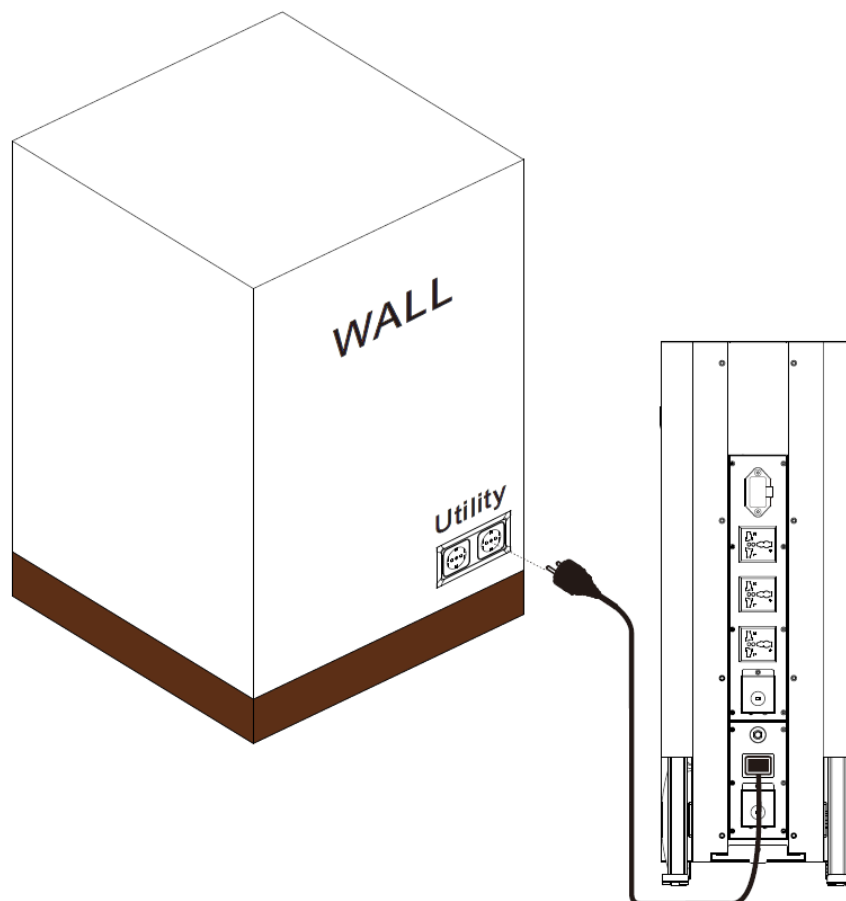

## PV Connection

There are two methods to connect PV panels.

1. Connect directly on the terminal block.
2. Using a pluggable connector.

### Direct Terminal Connection

1. Take off the PV connector cover by removing screws as shown below.
2. Install the cable gland to connector cover.
3. Fixing the PV cables on the terminal.
4. Install cover back to the rear panel.

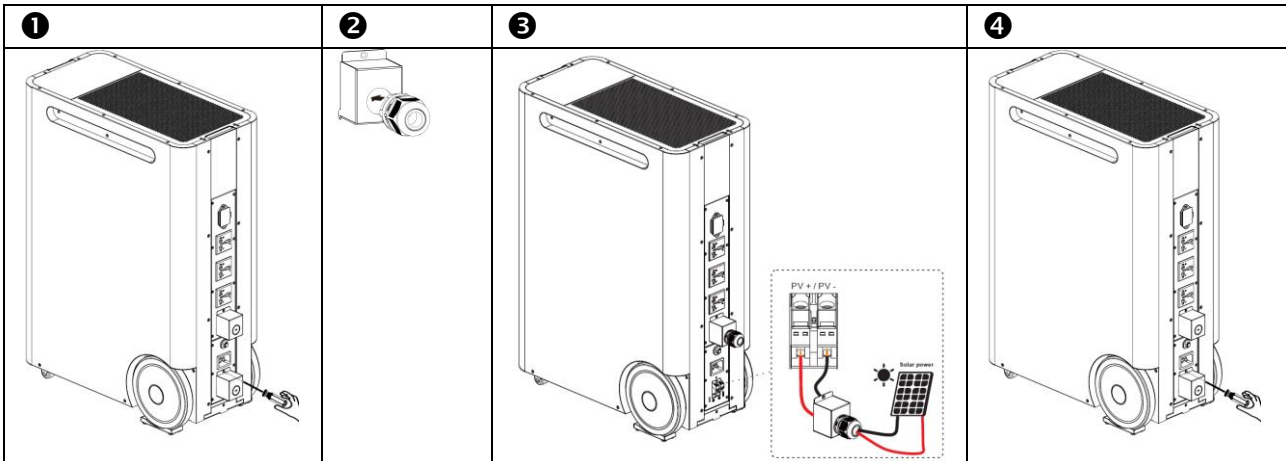

### Pluggable Connector Connection

Please follow below steps to implement PV module connection:

1. Take off the PV connector cover by removing screws as shown below.
2. Install the cable gland.
3. Check correct polarity of wire connection from PV modules and PV input terminals.  
Connect positive pole (+) of connection wire to positive pole (+) of PV input terminal. Connect negative pole (-) of connection wire to negative pole (-) of PV input terminal.
4. Install cover back to the rear panel.

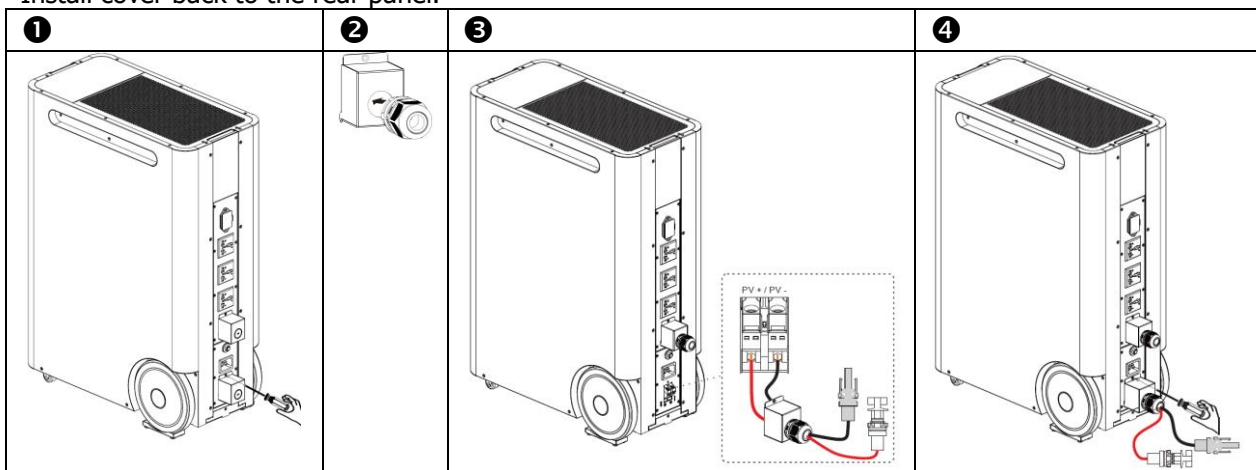

# AC Output Connection

**CAUTION:** If signal unit operation, please close the cover of parallel socket to reduce risk of electric shock. Plug AC power cord on the AC output socket.

Output powered when the main switch on the front panel pressed for 3 sec.

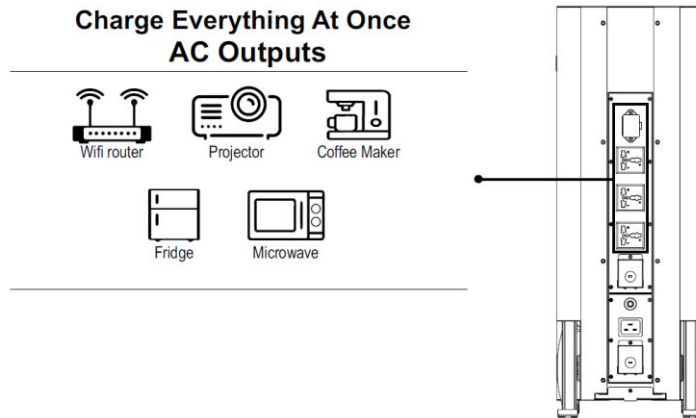

In case the load rating higher than the socket could support (>13Amp), please connect the power cable on the AC output terminal block. Before doing that, please be sure the unit is "OFF" completely.

1. Remove insulation sleeve 10mm for three conductors. And shorten phase L and neutral conductor N 3 mm.
2. Insert AC output wires according to polarities indicated on terminal block and tighten the terminal screws. Be sure to connect PE protective conductor (**G**) first.
3. Make sure the wires are securely connected and then knock terminal cover to install cable gland.
4. Insert the terminal cable to cable gland, and install cover box on rear panel.

**CAUTION: Important**  
Please install the terminal cover firmly to reduce risk of electric shock

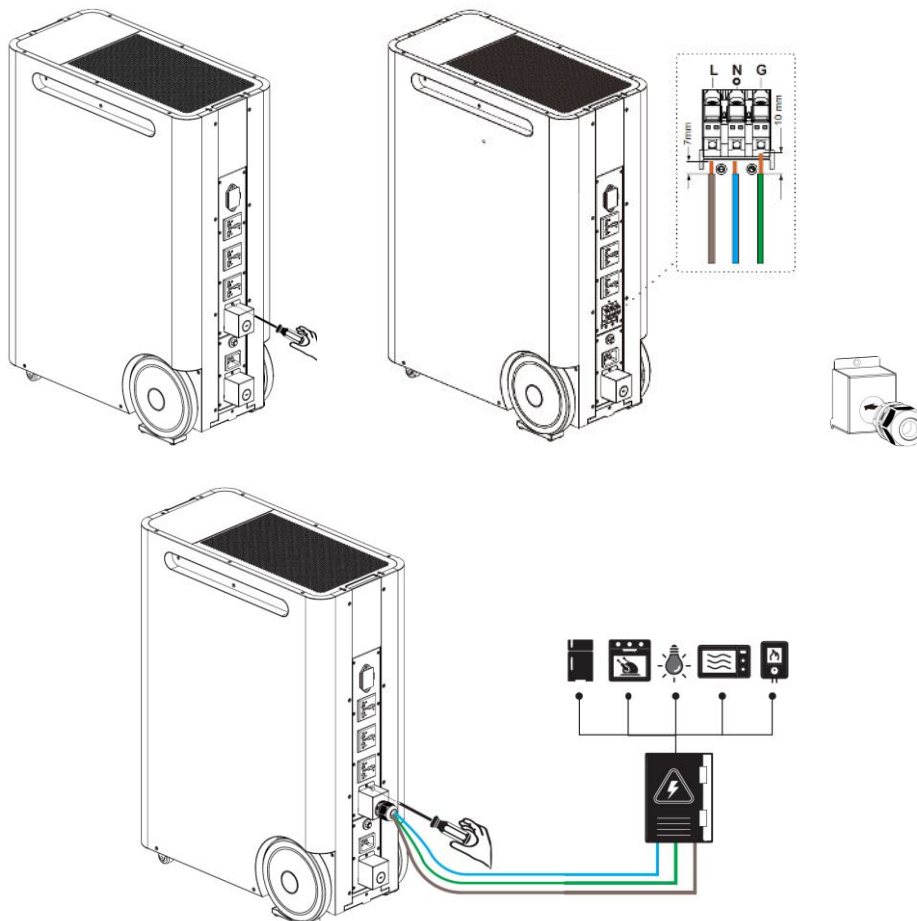

## USB Charger

Use USB output cable (not provided) to charge your electronic devices.  
USB charger port could be turned on/off through the LCD operation.

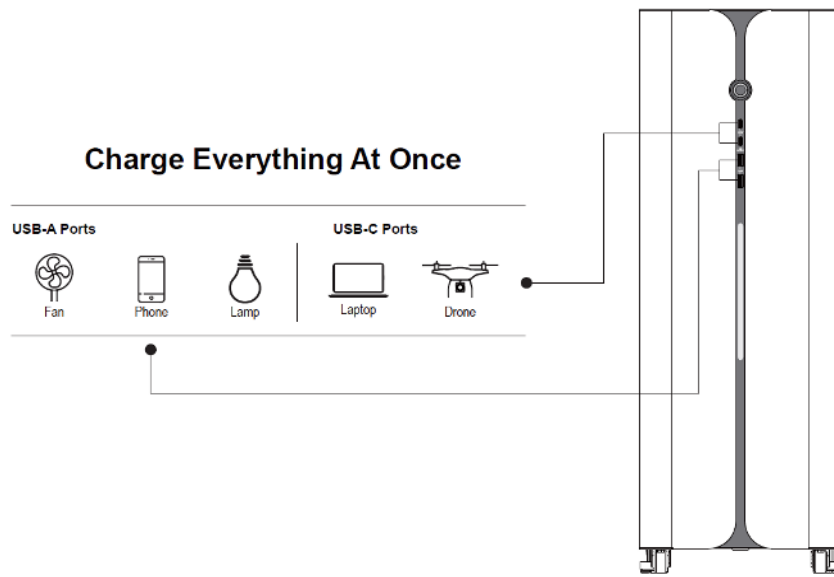

# Parallel Function

## 1. Introduction

This portable energy bank can be operated in parallel with 2 units. The supported maximum capacity is 6KW. If longer backup time is required, this unit can be connected with more battery modules up to 2 units.

**CAUTION: Parallel feature will be disabled when only PV power is available.**

## 2. System Configuration

There are several configurations available as shown below.

**Note:** The gray unit in the picture is the external battery module.

### Expand Battery Capacity

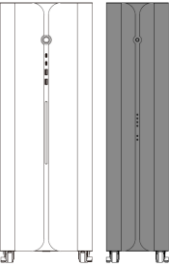
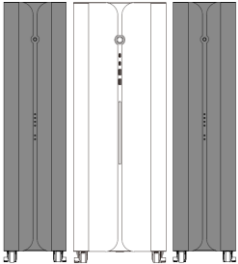
		
3KW, 2.5KWh	3KW, 5.0KWh	3KW, 7.5KWh

### Expand Power and Battery Capacity

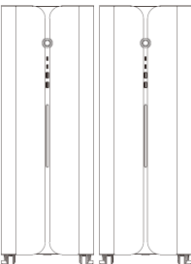
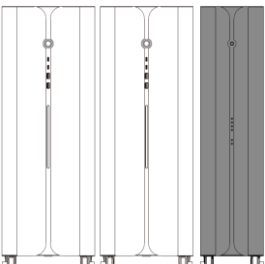
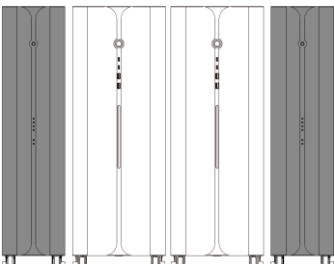
		
6KW, 5.0KWh	6KW, 7.5KWh	6KW, 10KWh

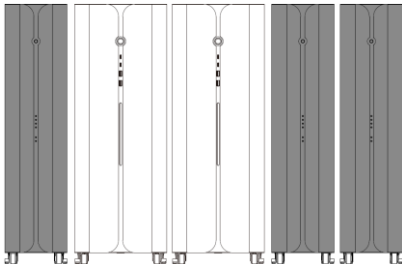
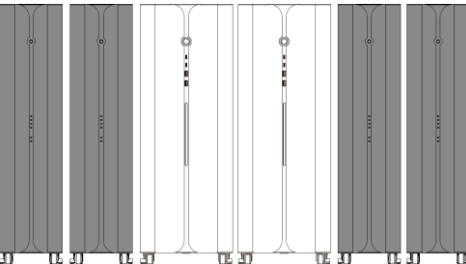
	
6KW, 12.5KWh	6KW, 15KWh

### 3. Preparation

Before connecting all wires, be sure to take off top panel and wire cover by removing six screws. Refer to below chart for the details.

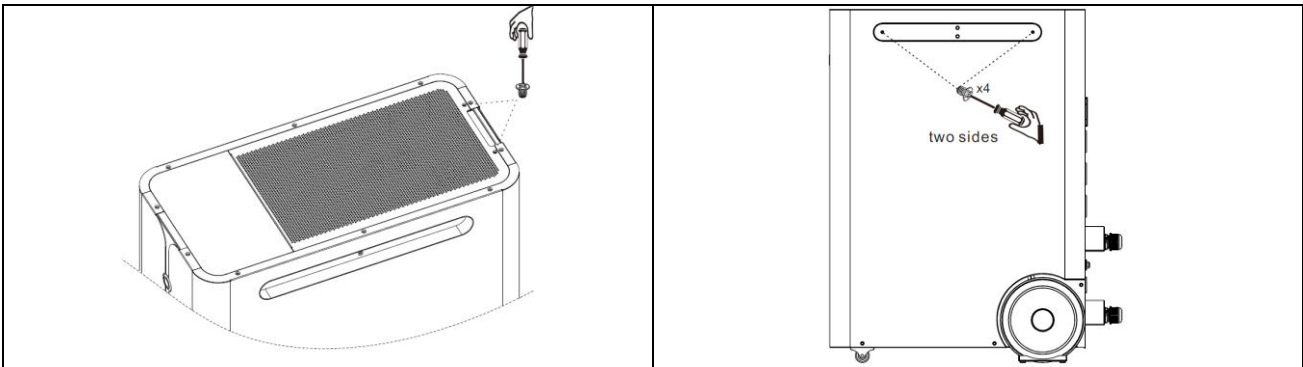

### 4. External Battery Connection

If longer backup time is required, it's necessary to connect external battery modules. Maximum connection number is two.

**CAUTION:** Before connecting to battery modules, please **disconnect** the DC breaker located on the top of the unit.

**Step 1:** Follow the polarity near the battery terminal to connect battery terminals with two battery cables supplied in external battery module! Simply plug battery cable to battery terminals on PEB module and external battery module as shown below charts.

#### Expand Battery Capacity

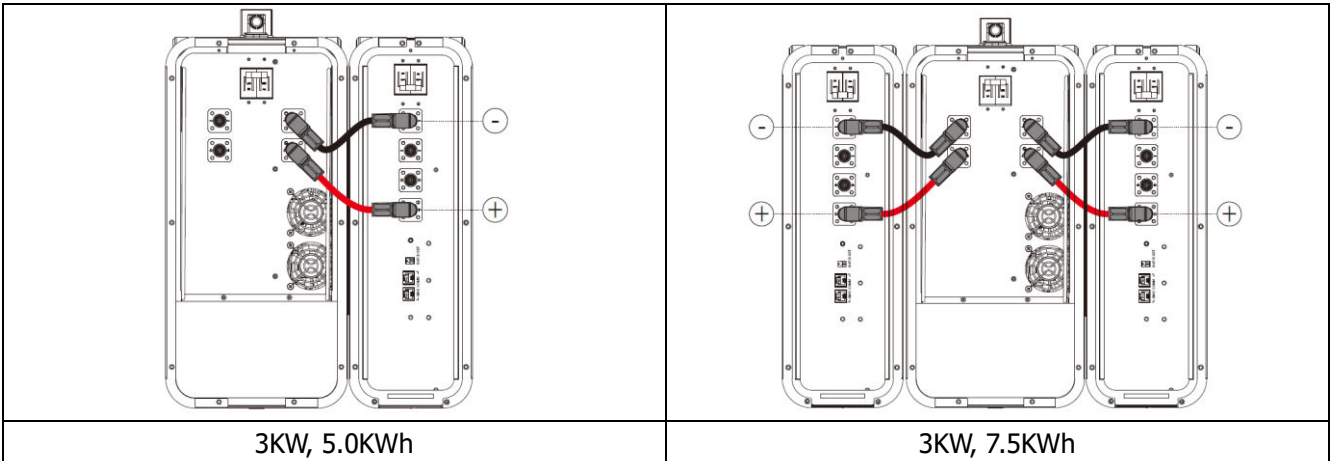

#### Expand Output Power and Battery Capacity

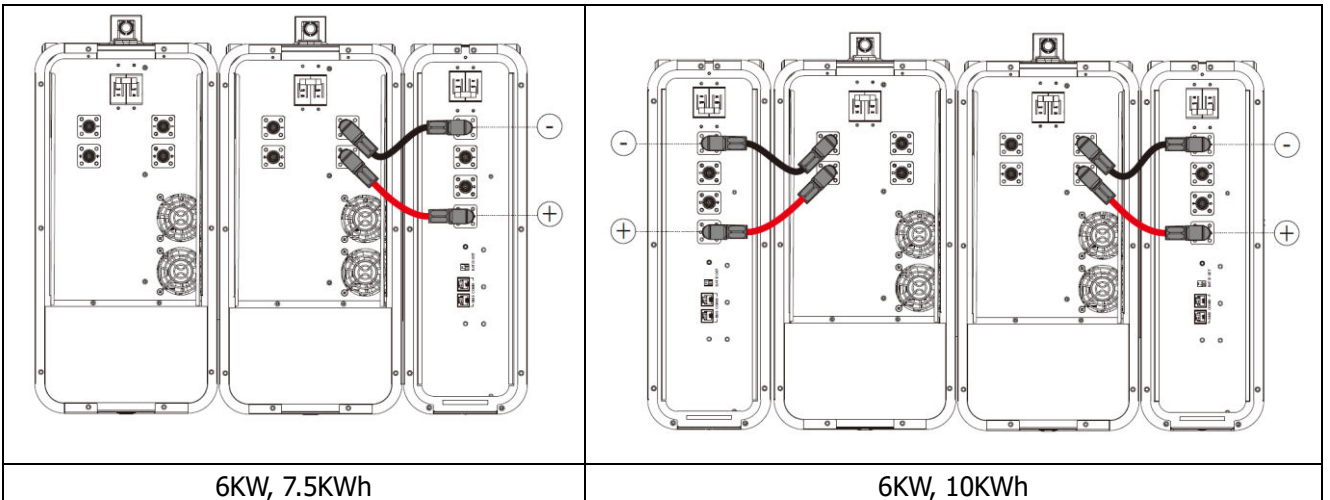

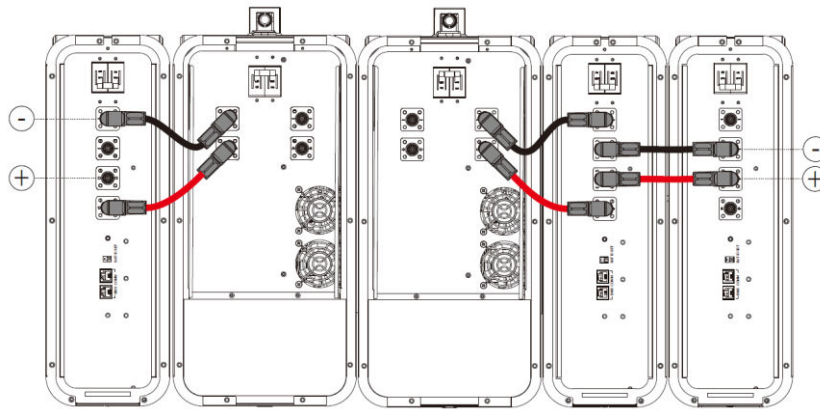

6KW, 12.5KWh

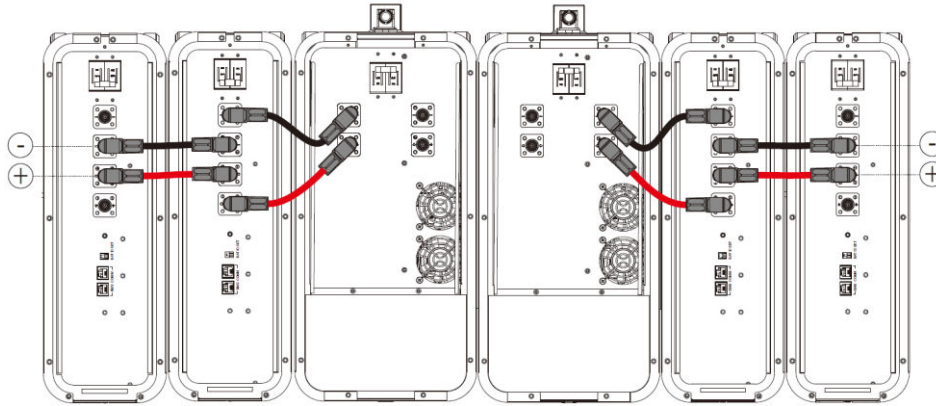

6KW, 15KWh

**NOTICE:** It's not applied for common battery when expanding the output power with 2 units. External battery module only connects to its integrated main unit.

**Step 2:** Connect extension port on the battery modules with RJ11 cables (supplied in the external battery module). After wiring installation is complete, set up ID for each battery module. The ID code for each battery module **MUST** be unique. Not the same number for 2 battery modules in parallel system. Refer below chart for the details.

**NOTE:** ID Switch indicates the unique ID code for each battery module. It's required to assign a unique ID to each battery module for normal operation. From number 0 to 1, the number can be random; no particular order. Maximum 2 battery modules can be operated in parallel.

### Expand Battery Capacity

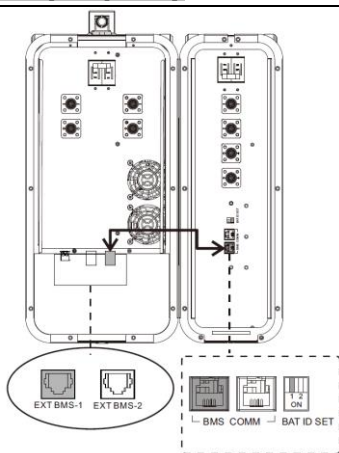

3KW, 5.0KWh

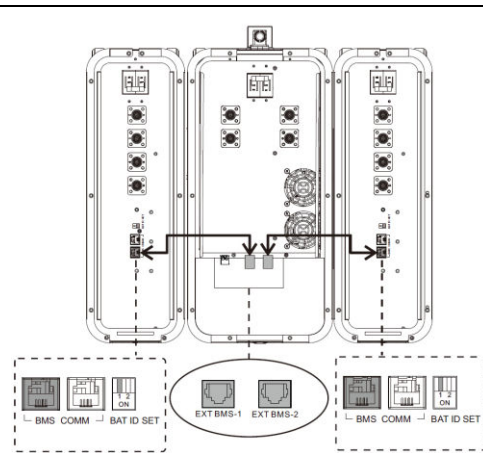

3KW, 7.5KWh



## Expand Output Power and Battery Capacity

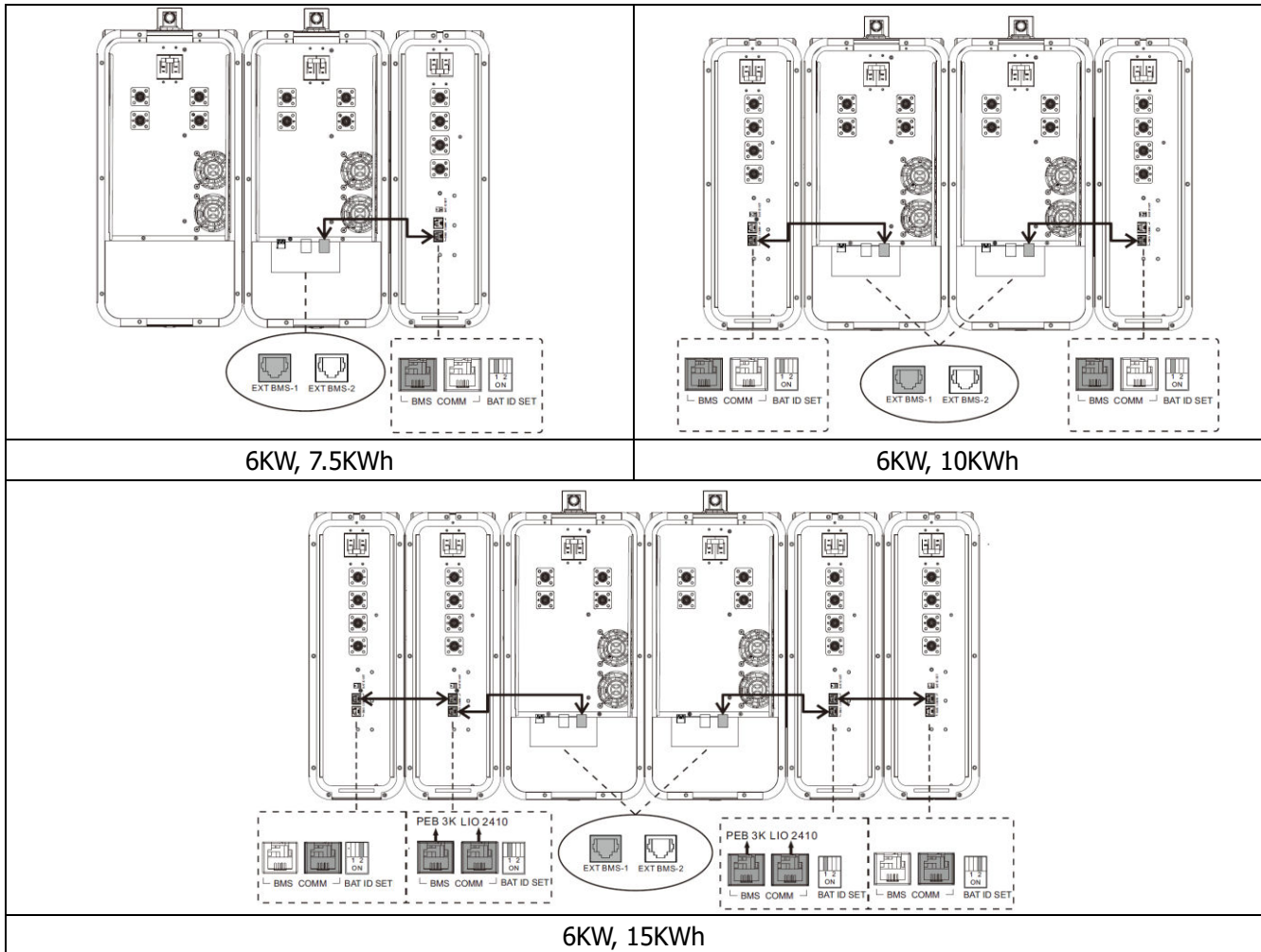

## 5. AC Output Connection

Open the parallel port cover and use one parallel cable (purchased separately) to connect the parallel ports on the two main unit. Once paralleled units are powered on, you can plug devices on either Master or Slave unit.

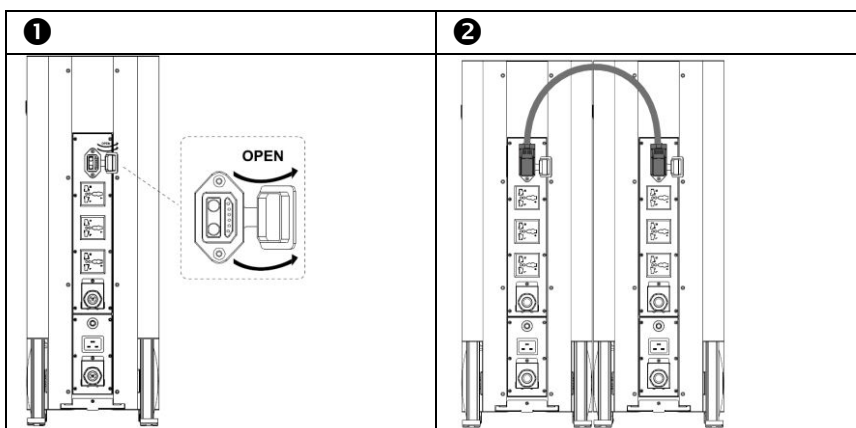

When parallel system is operated successfully, the LCD information on **Master** and **Slave** will present.

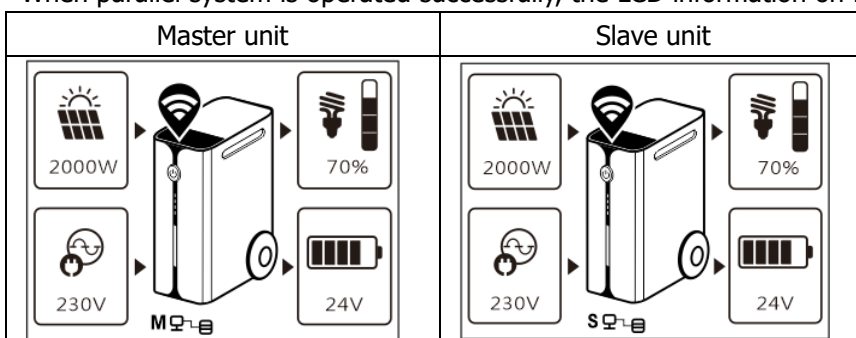



# OPERATION

The unit is equipped with rechargeable Lithium battery. Be sure to charge the battery at least more than 12 hours before initial use. To accurate the calculation of battery capacity, it's recommended to have fully charged and discharged for 1~2 times. For long-term storage, it's necessary to fully charge the battery, disconnect the internal DC breaker and store it in a cool, dry place.

## Power ON/OFF



Once the unit has been properly installed and the batteries are connected well, simply press power button to turn on the unit.





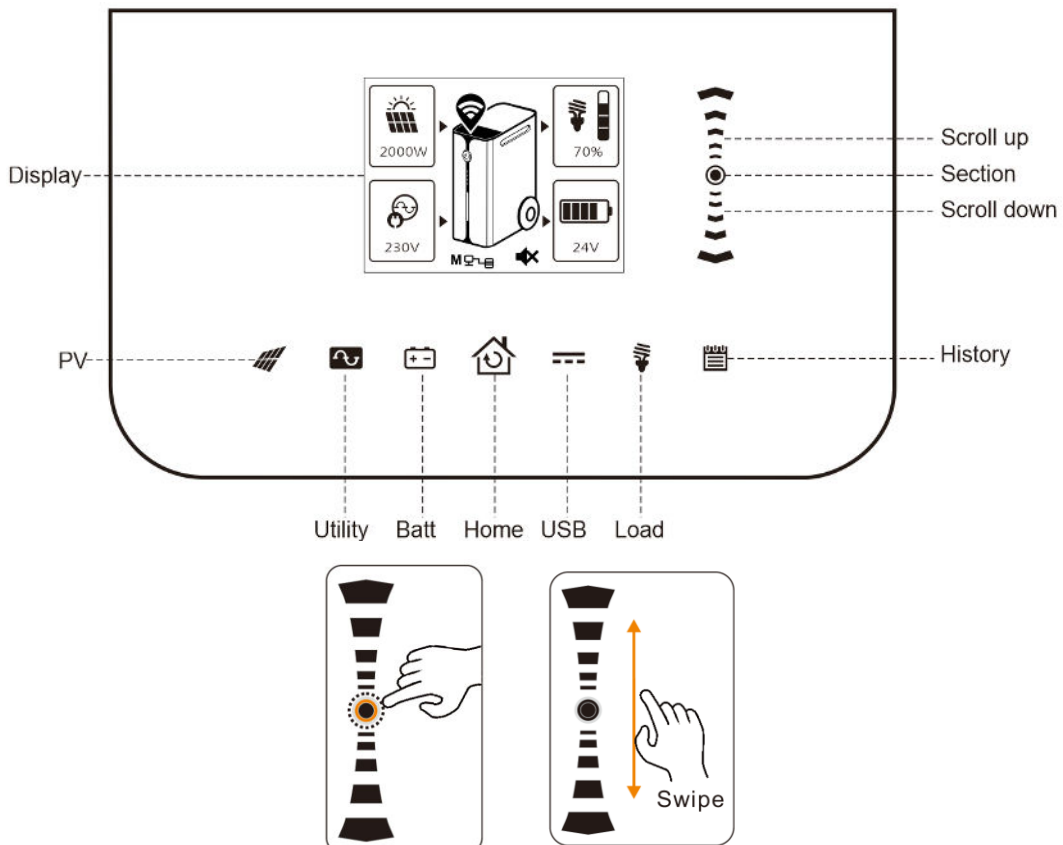







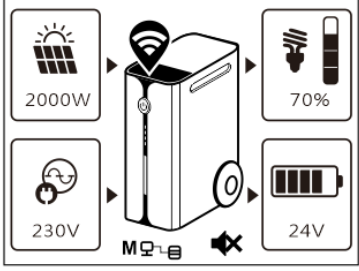
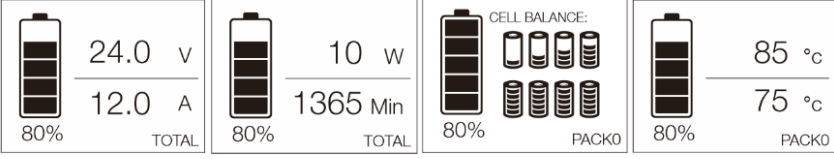





























## Operation and Display Panel

The operation and display panel, shown in below chart, is located on the top of the unit. It includes seven-page colorful LCD display, scrollbar and graphic touch pads, indicating the operating status and input/output power information.



# Pages Information

When the unit is turned on, the LCD display will show home page after few seconds.

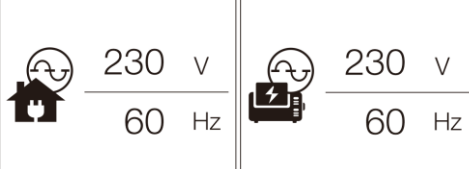
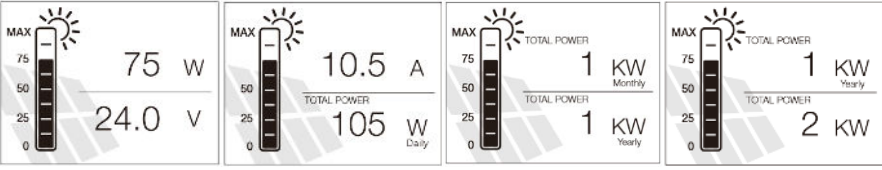
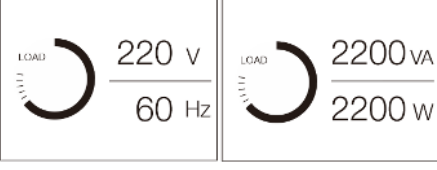
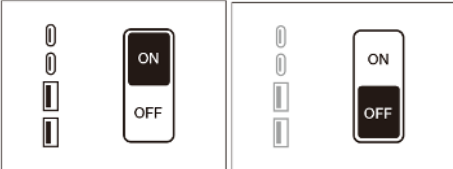
<p><b>Home page: (tap  icon 0.5s)</b>  <b>indicates the summarized power flow and energy information.</b></p> 																													
<p><b>Battery page:</b>  <b>indicates the battery cell and pack information.</b></p>																													
<p><b>Cell indication in battery page:</b></p>																													
<table border="1" style="width: 100%; text-align: center;"> <tr> <td></td> <td></td> <td></td> <td></td> <td></td> <td></td> <td></td> </tr> <tr> <td>Cell &gt;= 3.7V</td> <td>3.7V &gt; Cell &gt;= 3.5V</td> <td>3.5V &gt; Cell &gt;= 3.2V</td> <td>3.2V &gt; Cell &gt;= 3.0V</td> <td>3.0V &gt; Cell &gt;= 2.7V</td> <td>2.7V &gt; Cell &gt;= 2.5V</td> <td>Cell &lt; 2.5V</td> </tr> <tr> <td></td> <td></td> <td></td> <td></td> <td></td> <td></td> <td></td> </tr> <tr> <td>SOC 100%</td> <td>SOC 80%</td> <td>SOC 60%</td> <td>SOC 40%</td> <td>SOC 20%</td> <td>SOC 0%</td> <td></td> </tr> </table>									Cell >= 3.7V	3.7V > Cell >= 3.5V	3.5V > Cell >= 3.2V	3.2V > Cell >= 3.0V	3.0V > Cell >= 2.7V	2.7V > Cell >= 2.5V	Cell < 2.5V								SOC 100%	SOC 80%	SOC 60%	SOC 40%	SOC 20%	SOC 0%	
																													
Cell >= 3.7V	3.7V > Cell >= 3.5V	3.5V > Cell >= 3.2V	3.2V > Cell >= 3.0V	3.0V > Cell >= 2.7V	2.7V > Cell >= 2.5V	Cell < 2.5V																							
																													
SOC 100%	SOC 80%	SOC 60%	SOC 40%	SOC 20%	SOC 0%																								
<p><b>AC input page:</b>  <b>indicates the AC input source type and information.</b></p>																													
<p><b>PV page:</b>  <b>indicates the PV information.</b></p>																													
<p><b>AC output page:</b>  <b>indicates the AC output information.</b></p>																													
<p><b>USB charger page:</b>  <b>real-time control on the output of USB charger ports.</b></p>																													

**Logs page:**  
**indicates all event, warning,**  
**and fault messages.**

10-10, 18:30  
W01  
Grid not exist  
1/15

# Configurations

Press  icon for 3s to enter the setting menu.

There are three sub-menus: Information, Basic and Advanced.

Click  icon again to exit setting return Home page.

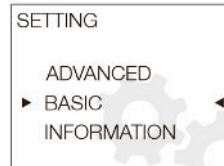

## Information

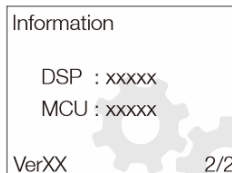
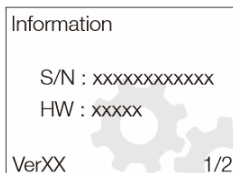

## Basic

Change the main page

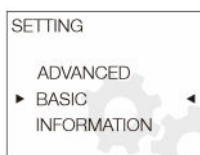

Setup home page

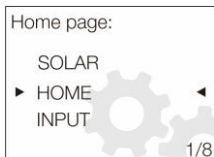

Turn on/off Wi-Fi module

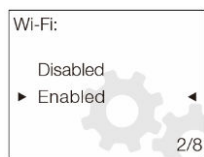

Turn on/off buzzer

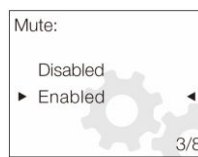

Setup date

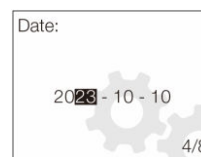

Setup time

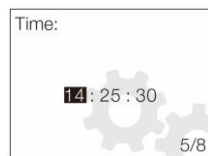

Setup log record duration

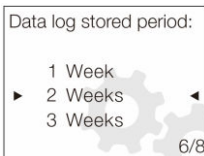

Enable screen off timer

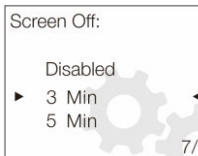

Change RGB LED color



## Advanced

Configure the nominal voltage and frequency

Default: 230Vac, 50Hz (or 120Vac, 60Hz)

Note: 120VAC and 230VAC belongs to different model.

Inverter Voltage:



Inverter Frequency:



Configure the output and charger source priority

Regular: Priority arranged per day

Schedule: Priority arranged per hours

Default: Regular

Output Source Priority:

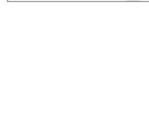
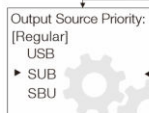

Charger Source Priority:

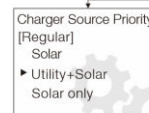

Configure the stop and restart discharging capacity and minimum SOC

Default: 10%, 80%, 10%

Stop Discharging SOC:



Start Re-Discharging SOC:



Minimum SOC Level:



<p>Configure the maximum charging current and limitation while charging from Utility</p> <p>Default: 50A, 30A</p>	<div style="display: flex; justify-content: space-around;"> <div style="border: 1px solid black; padding: 5px; width: 45%;"> <p>Charging Speed:</p> <p>Super charge, 100A</p> <p>▶ Fast, 50A ◀</p> <p>Normal, 30A</p> <p style="text-align: right;">8/17</p> </div> <div style="border: 1px solid black; padding: 5px; width: 45%;"> <p>Utility Charging Speed:</p> <p>Trickle, 10A</p> <p>▶ Normal, 30A ◀</p> <p>Fast, 50A</p> <p style="text-align: right;">9/17</p> </div> </div>
<p>Configure the limitation of discharging current</p> <p>Default: Disabled (means no limited)</p> <p>**Parallel application will disable the discharging limitation</p>	<div style="border: 1px solid black; padding: 5px;"> <p>Max. Discharging Current:</p> <p>Disabled</p> <p>▶ 30 A ◀</p> <p>40 A</p> <p style="text-align: right;">10/17</p> </div>
<p>Configure the compatibility of AC input source</p> <p>Default: Utility</p>	<div style="border: 1px solid black; padding: 5px;"> <p>AC Input Source:</p> <p>Utility</p> <p>▶ Generator ◀</p> <p style="text-align: right;">11/17</p> </div>
<p>Configure fault or overload behaviors</p> <p>Default: Disabled, Disabled</p>	<div style="display: flex; justify-content: space-around;"> <div style="border: 1px solid black; padding: 5px; width: 45%;"> <p>Fault Auto-restart:</p> <p>Disabled</p> <p>▶ Enabled ◀</p> <p style="text-align: right;">12/17</p> </div> <div style="border: 1px solid black; padding: 5px; width: 45%;"> <p>Overload Bypass:</p> <p>Disabled</p> <p>▶ Enabled ◀</p> <p style="text-align: right;">13/17</p> </div> </div>
<p>Specific critical operations (Password 4743 is necessary)</p> <ul style="list-style-type: none"> <li>- Reset to factory setting</li> <li>- Erase all logs</li> <li>- Export all logs</li> <li>- Firmware upgrade</li> </ul>	<div style="display: flex; flex-direction: column;"> <div style="display: flex; justify-content: space-between; margin-bottom: 10px;"> <div style="border: 1px solid black; padding: 5px; width: 22%;"> <p>Erase all data log:</p> <p>Password</p> <p>0000</p> <p style="text-align: right;">14/17</p> </div> <div style="border: 1px solid black; padding: 5px; width: 22%;"> <p>Reset to default:</p> <p>Password</p> <p>0000</p> <p style="text-align: right;">15/17</p> </div> <div style="border: 1px solid black; padding: 5px; width: 22%;"> <p>Firmware Upgrade:</p> <p>Password</p> <p>0000</p> <p style="text-align: right;">16/17</p> </div> <div style="border: 1px solid black; padding: 5px; width: 22%;"> <p>Export Logs:</p> <p>Password</p> <p>0000</p> <p style="text-align: right;">17/17</p> </div> </div> <div style="display: flex; justify-content: space-between; margin-bottom: 10px;"> <div style="border: 1px solid black; padding: 5px; width: 22%;"> <p>Erase all data log:</p> <p>Reset</p> <p>▶ Not reset ◀</p> </div> <div style="border: 1px solid black; padding: 5px; width: 22%;"> <p>Reset to default:</p> <p>Disabled</p> <p>▶ Enabled ◀</p> </div> <div style="border: 1px solid black; padding: 5px; width: 22%;"> <p>Firmware Upgrade:</p> <p>YES</p> <p>▶ NO ◀</p> </div> <div style="border: 1px solid black; padding: 5px; width: 22%;"> <p>Export Logs:</p> <p>YES</p> <p>▶ NO ◀</p> </div> </div> <div style="border: 1px solid black; padding: 5px;"> <p>Invalid password, try again</p> <div style="display: flex; justify-content: space-between; margin-top: 10px;"> <div style="border: 1px solid black; padding: 5px; width: 22%;"> <p>Erase all data log:</p> <p>Invalid!</p> <p>0000</p> </div> <div style="border: 1px solid black; padding: 5px; width: 22%;"> <p>Reset to default:</p> <p>Invalid!</p> <p>0000</p> </div> <div style="border: 1px solid black; padding: 5px; width: 22%;"> <p>Firmware Upgrade:</p> <p>Invalid!</p> <p>0000</p> </div> <div style="border: 1px solid black; padding: 5px; width: 22%;"> <p>Export Logs:</p> <p>Invalid!</p> <p>0000</p> </div> </div> </div> </div>

## Wi-Fi Connection

This unit is equipped with a Wi-Fi transmitter. Wi-Fi transmitter can enable wireless communication between portable energy bank and monitoring platform. Users can access and control the monitored portable energy bank with downloaded APP. Once Wi-Fi connection successfully, the Wi-Fi icon will be showed on the LCD.

For quick installation and operation, please refer to Appendix I - The Wi-Fi Operation Guide for details.

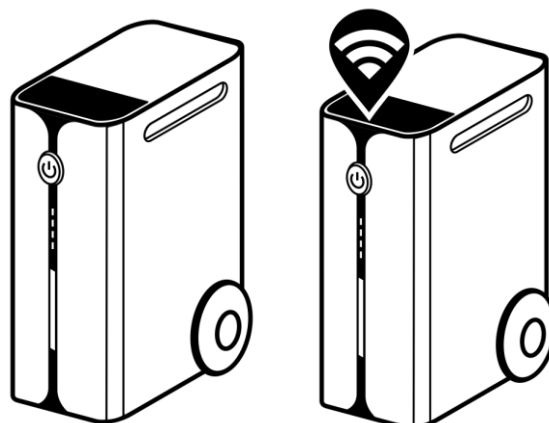

## Prioritizing Energies Scenarios

(Noted: following demonstrations do not include and calculate the real conversion efficiency of the unit.)

A) Load supplied from Solar firstly then Battery and Utility

Output Source Priority:

- USB
- ▶ SBU ◀
- SUB

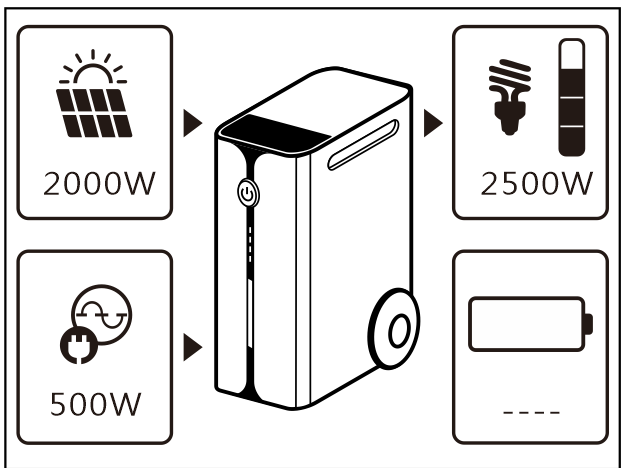
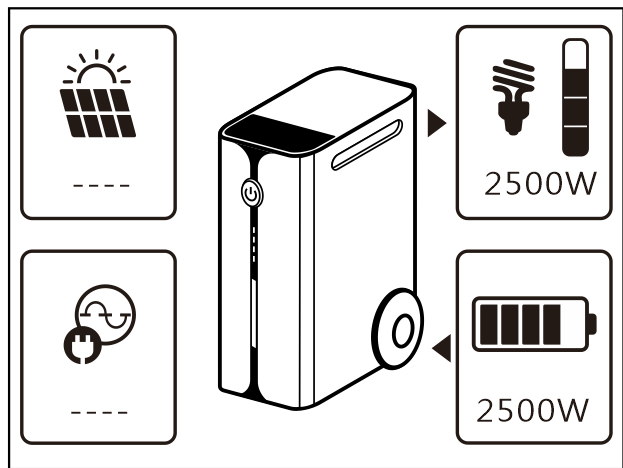
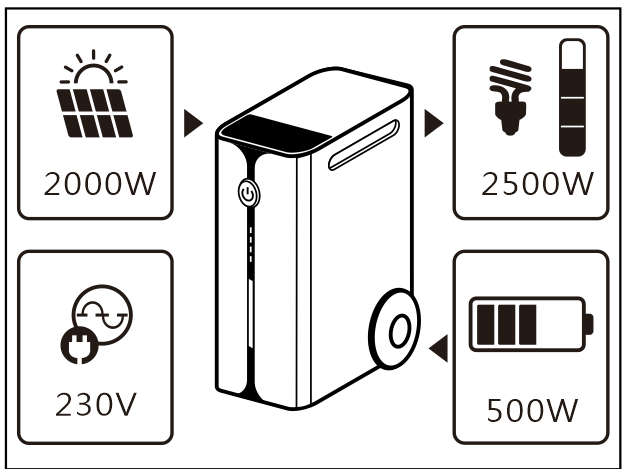
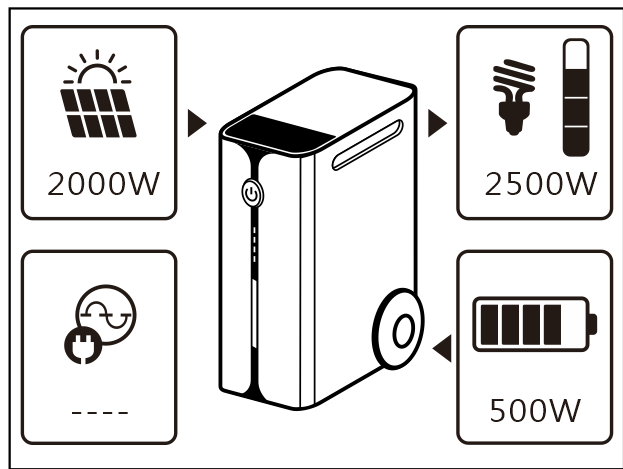
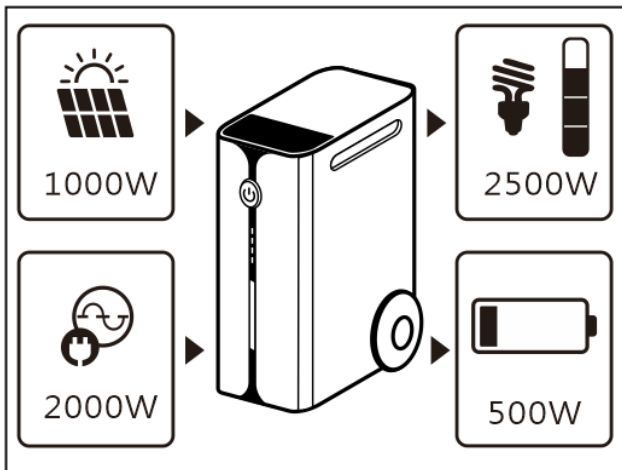
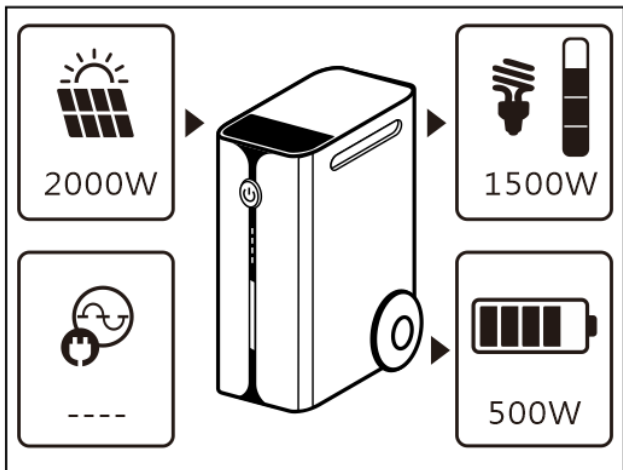
B) Load supplied from Solar firstly then Utility and Battery

Output Source Priority:

- USB
- ▶ SUB
- SBU

C) Load supplied from Utility firstly then Solar and Battery

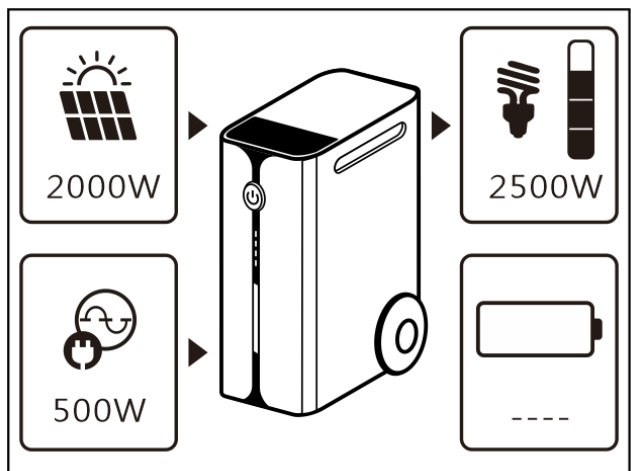
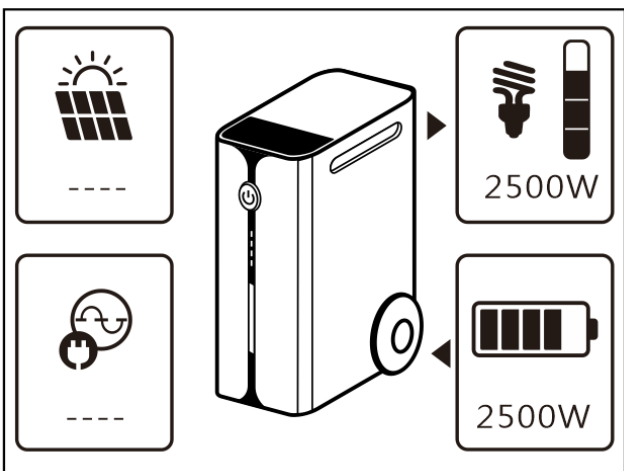
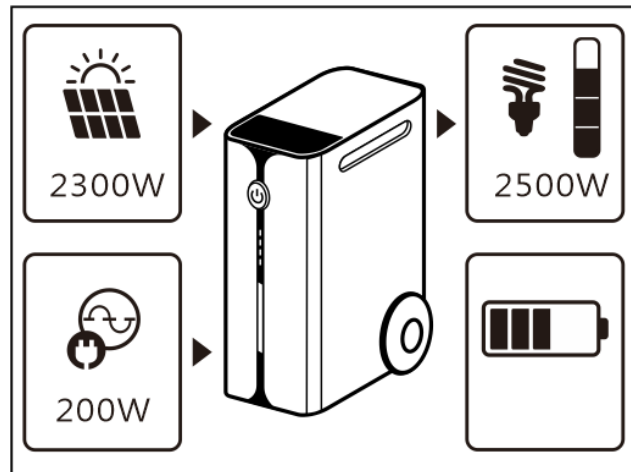
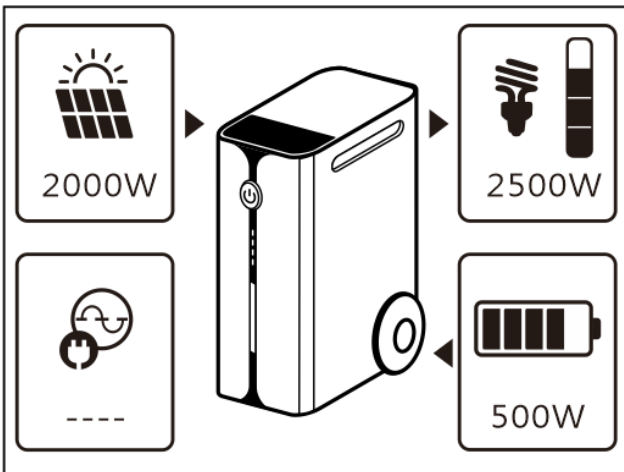
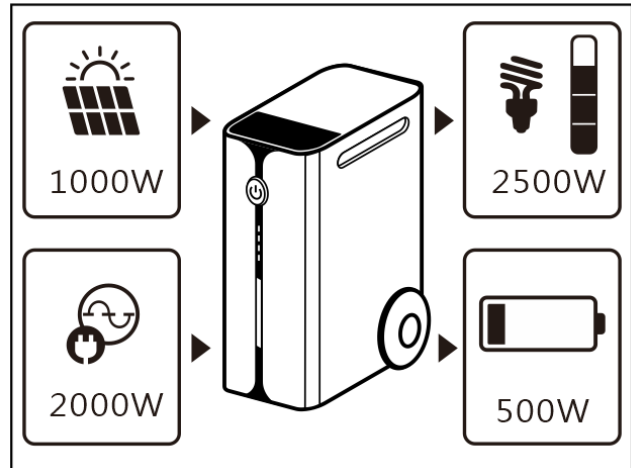
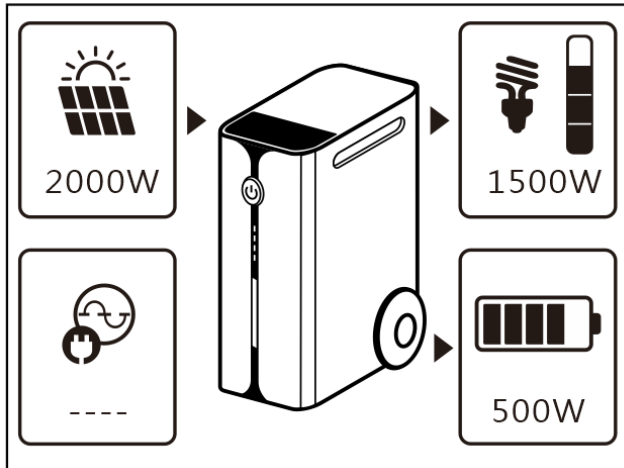

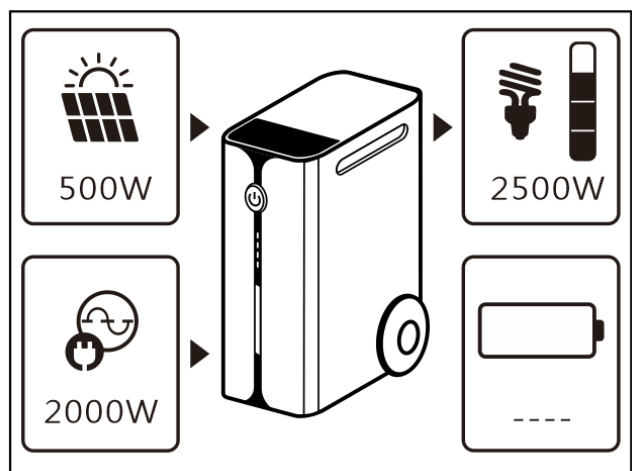
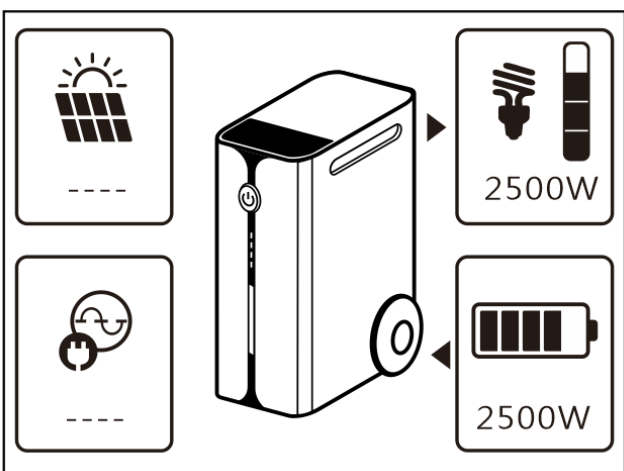
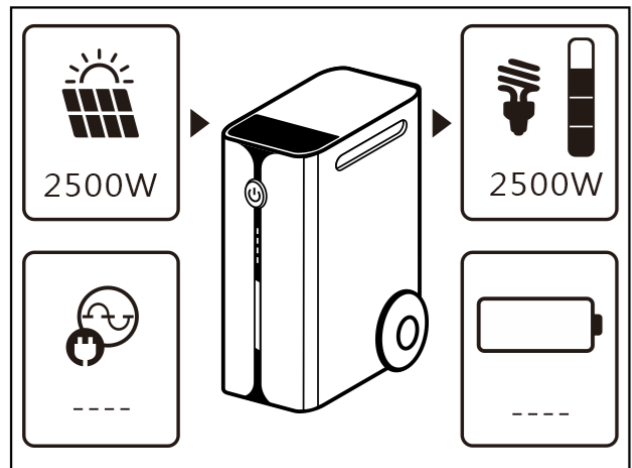
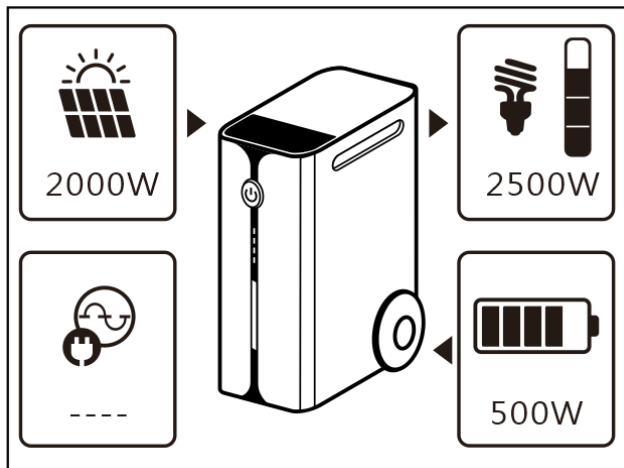
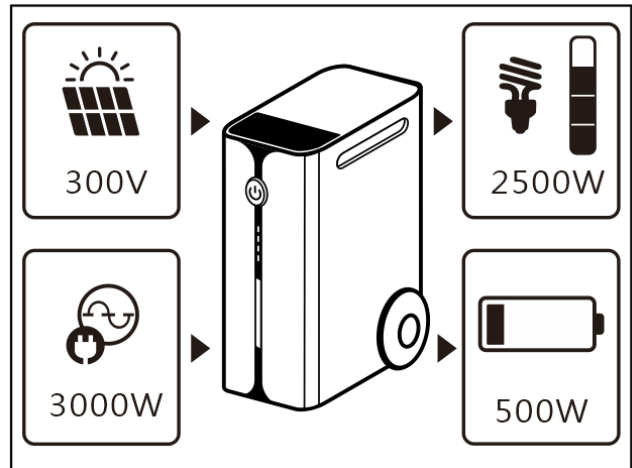
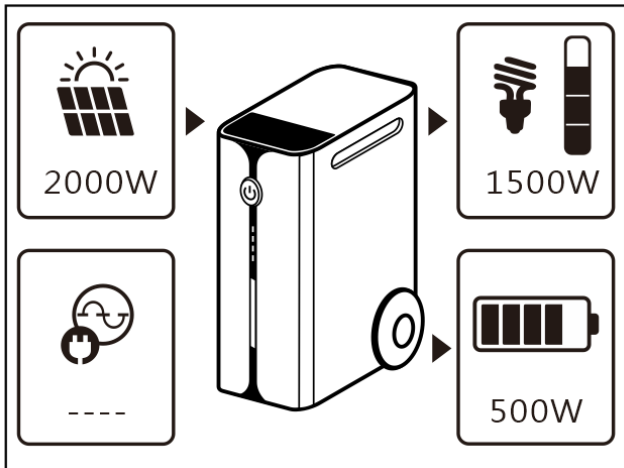
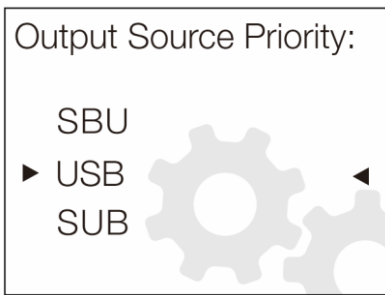

# CLEARANCE AND MAINTENANCE FOR ANTI-DUST KIT

## Overview

Every unit is already installed with anti-dusk kit from factory. This kit keeps dusk from your unit and increases product reliability in harsh environment.

## Clearance and Maintenance

**Step 1:** Please loosen the screw on the rear-panel bottom side of the unit.

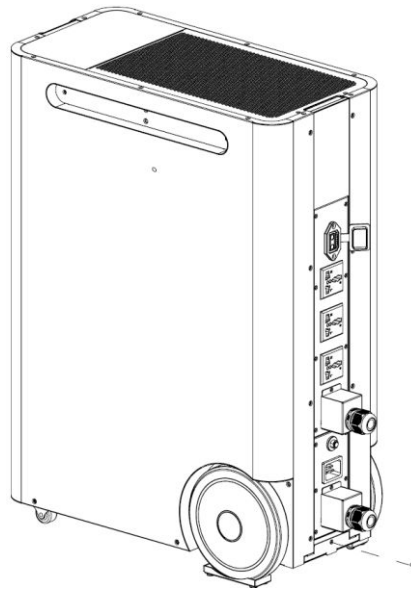

**Step 2:** Then, dustproof case can be pulled out and take out air filter foam as shown in below chart.

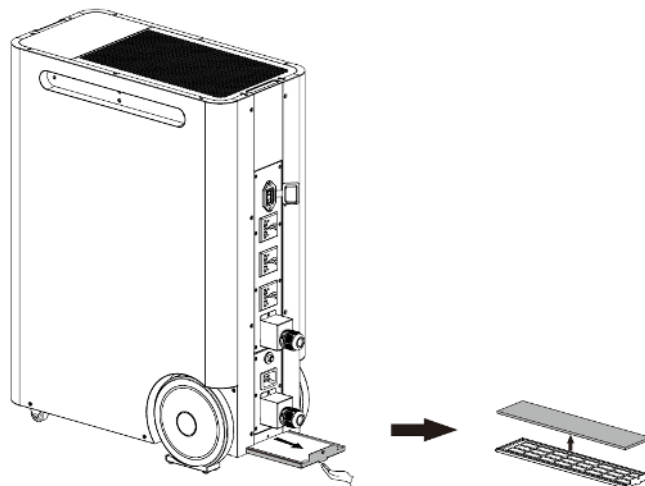

**Step 3:** Clean air filter foam and dustproof case. After clearance, re-assemble the dust kit back to the unit.

**NOTICE:** Regular cleaning for the filter per 3 months is recommended.

## SPECIFICATIONS

<b>Rated Inverter Power</b>	3000VA / 3000W
<b>INPUT</b>	
Voltage	100VAC/110VAC/120VAC or 220VAC/230 VAC/240VAC
Selectable Voltage Range	60VAC ~ 140VAC or 90VA ~ 280VAC
Frequency Range	50 Hz/60 Hz (Auto sensing)
Max. Current and Protection	20A, Circuit breaker build-in
<b>OUTPUT</b>	
AC Voltage Regulation (Batt. Mode)	100VAC/110VAC/120VAC or 220VAC/230VAC/240VAC ± 5%
Surge Power	6000VA
Efficiency (Peak)	93%
Transfer Time	15ms ~ 20ms
Waveform	Pure Sine Wave
<b>USB CHARGER</b>	
DC Output ports	Type A * 2, Type C * 2 (comply with PD 3.0)
USB-A	18W * 2 (5V/3A,9V/2A)
USB-C	65W * 2 (5V/3A,9V/2A,20V/3.25A)
<b>SOLAR &amp; AC CHARGER</b>	
Solar Charger type	MPPT
Maximum PV Power	3000W
MPPT Range @ Operating Voltage	60VDC ~ 400VDC
Maximum PV Open Circuit Voltage	450VDC
Maximum Charge Current	100A
<b>BATTERY MODULE</b>	100A
Capacity	2560Wh
Nominal Voltage	25.6 VDC
Full Charge Voltage	28.2 VDC
Full Discharge Voltage	22.0 VDC
Max. Discharging Current	200A
Protection	BMS, Breaker
Inner Resistance	≤0.6 mohm
Lifecycle	≥3500 cycles, 0.5C charging/discharging ≥80% @EOL 100% DoD
<b>INTERFACE</b>	
Function Keys	Touch PAD
Display	True Color LCD + RGB LED
Communication	Wi-Fi
<b>PHYSICAL</b>	
Dimension, D X W X H (mm)	450 x 600 x 222
Net Weight (kgs)	42
<b>STANDARD</b>	
Compliance Safety	IEC/EN 62109-1/-2, EN 61000-6-4, EN-61000-6-2 IEC 62619, UN38.3

# TROUBLE SHOOTING

## Warning and Fault List

Code Type	Code #	Event	Code Type	Code #	Event
Fault	F01	Fan fault	Fault	F15	Bus start fault
Fault	F02	High PV-volt	Fault	F16	Inv start fault
Fault	F03	High bat-volt	Fault	F17	High dc offset
Fault	F04	Low bat-volt	Fault	F18	Over-load
Fault	F05	Output S.C.	Fault	F19	Amp sense fault
Fault	F06	High op-volt	Fault	F20	Backfeed fault
Fault	F07	Low op-volt	Fault	F21	Firmware fault
Fault	F08	High bus-volt	Fault	F22	Par-CAN fault
Fault	F09	Low bus-volt	Fault	F23	Par-host fault
Fault	F10	High PV-amp	Fault	F24	Par-sync fault
Fault	F11	High inv-amp	Fault	F25	Par-bat fault
Fault	F12	High bus-amp	Fault	F26	Par-grid fault
Fault	F13	High disc-amp	Fault	F27	Par-opa fault
Fault	F14	Over temp.	Fault	F28	Par-set fault
Warning	W01	Grid not exist	Warning	W07	Heavy load
Warning	W02	PV not exist	Warning	W08	Temp issue
Warning	W03	Pack not exist	Warning	W09	Fan issue
Warning	W04	Weak SoC	Warning	W10	BMS lost
Warning	W05	Weak PV-volt	Warning	W11	Comm. Lost
Warning	W06	Power de-rate	Warning	W12	Par limited

Phenomenon and/or Possible cause	What to do
<b>No response while press the main switch.</b>	
No Utility power and PV is applied.	Check whether the DC breaker tripped or has not yet turned on? If problem exist still, please contact the service center to repair it.
<b>No response while pressing the main switch.</b>	
Utility power or PV power exists.	Check whether the AC breaker tripped? Or PV voltage reaches to the operation level? If problem exist still, please contact the service center to repair it.
<b>Output turned off, Buzzer beeps continuously, RED LED solid on</b>	
F01 shows. Fans abnormal stopped during startup sequence	Please contact service center to replace them.
F02 shows.	Configure the PV panels lower than 450V.
F03 shows.	Disconnect the Utility and PV power. Then, re-apply again. If over-voltage alarm still, suppose the internal charger with some problem, please contact with service center to repair it.
F04 shows. Battery voltage dropped to an extremely low level	Please contact the service center to check if battery still in warranty period.

<b>Phenomenon and/or Possible cause</b>	<b>What to do</b>
F05 shows.	Check and verify if there is any load with short circuit condition? Remove the load and restart the unit again. If problem exist still, please contact the service center to repair.
F14 shows.	Clean the anti-dust filter and keep the unit installed in a well ventilated environment.
F18 shows.	Reduce the applied load and restart the unit again.
F21 shows.	New firmware doesn't compatible with the unit, please contact with service center to correct it.
F06, F07, F08, F09, F10, F11, F12, F13, F15, F16, F17, F19 or F20 shows.	Please restart the unit again. If problem exist still, please contact the service center to repair.
F22, F23, F24, F25, F26, F27 or F28 shows.	Please check if the parallel cable connected firmly. Restart the unis, if problem exist still, please contact with service center.
<b>Output powered but buzzer beeps per second, RED LED flashing</b>	
W04 shows.	Charge the battery.
W05 shows.	Reduce the load.
W06 shows.	Utility voltage lower to a certain level, the output rating will be limited.
W07 shows.	Reduce load will release the warning.
W08 shows.	Clean the anti-dust filter and keep the unit installed in a well ventilated environment.
W09 shows.	Fans abnormal stopped during operation. Please contact service center to replace them.
W10 shows.	BMS communication disconnected. Please contact service center to repair it.
W11 shows.	Internal communication disconnected. Please contact service center to repair it.
<b>WiFi mark is not displayed.</b>	
Unit can't connect to the APP.	Check the Wi-Fi function enabled and icon available on the LCD then follow the Wi-Fi installation procedure to pair the Wi-Fi module with router and APP.
<b>No function on USB charger ports.</b>	
No power from the USB charger ports.	Check whether the USB charger function is enabled.
<b>Parallel units can't be start-up successfully</b>	
W12 shows.	Please check if there is only PV source available. If only PV source is available, parallel system is not working. Try to connect Grid or Battery together with PV. The unit could supply load correctly.

# Appendix I: The Wi-Fi Operation Guide

## 1. Introduction

Wi-Fi module can enable wireless communication between inverter and monitoring platform. Users can remote monitoring and controlling inverter easily by using the i.Solar APP.

The major functions of this i.Solar APP:

- Delivers device status during normal operation.
- Allows to configure device setting after installation.
- Notifies users when a warning or alarm occurs.
- Allows users to query inverter history data.

## 2. i.Solar App

### 2-1. Download and install APP

Please find "i.Solar" app from Apple® store or Google® Play Store. Install this app in your mobile phone.

### 2-2. Initial Setup

- Turn on the unit.
- Open the Wi-Fi settings from your smart phone.
- Connect your smart phone to the Wi-Fi module. The Wi-Fi named starts with "FC41D\_".
- Default password for the Wi-Fi module is: 12345678

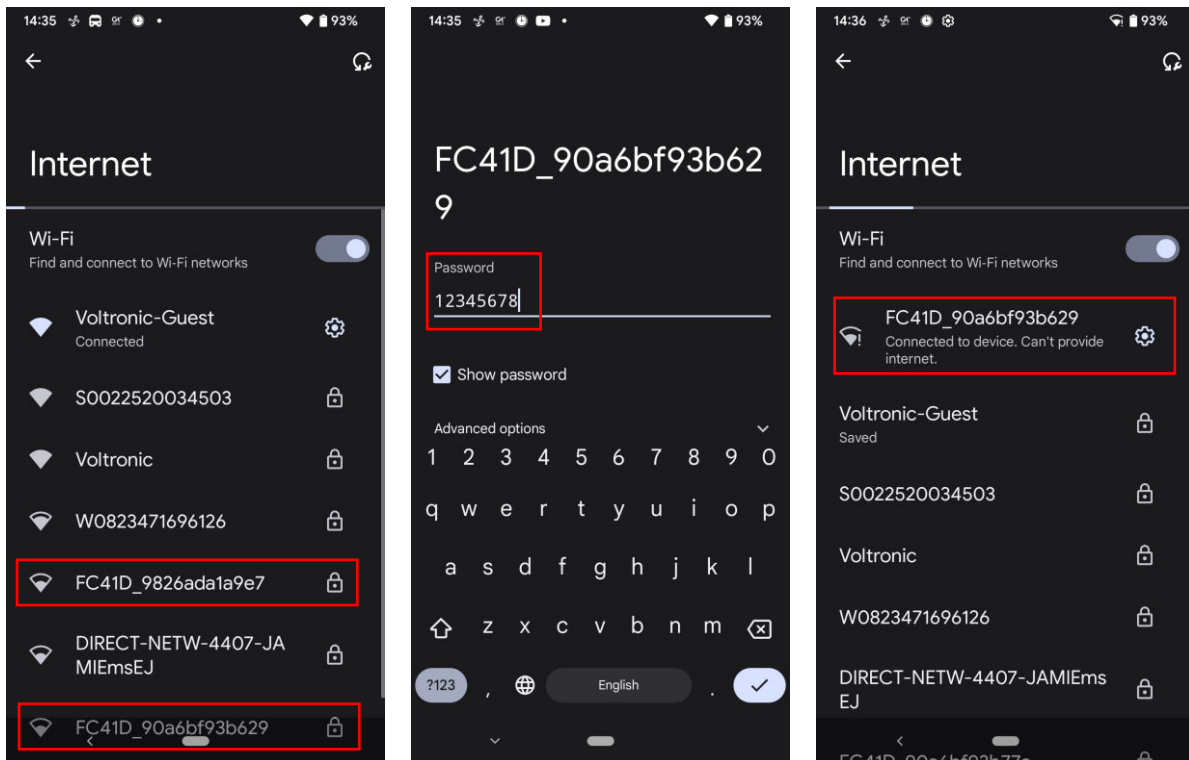

- Once the Wi-Fi connection is successful, click the i.Solar App installed on the phone to enter the login page. Then, click the "Network Config" button to enter the Wi-Fi configuration page.

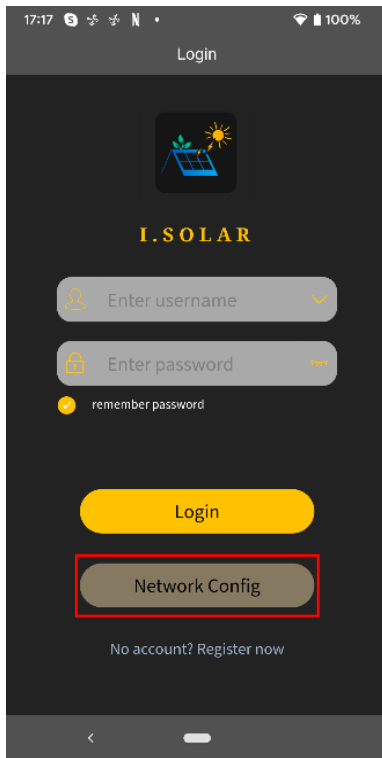

- The configuration page of the "Network Config" shown as following.

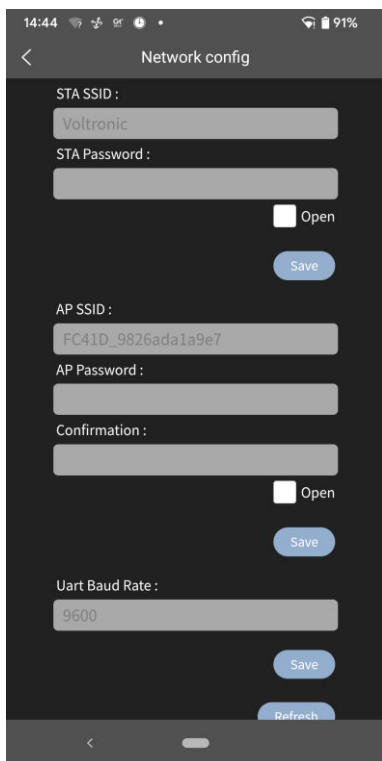

- Enter your router name (STA SSID) and router password (STA Password), then click the "Save" button to complete the setting.

If you check "Open" checkbox, you only need to enter the router name (STA SSID), no need to enter the router password. Then, click the "Save" button to complete the setting.

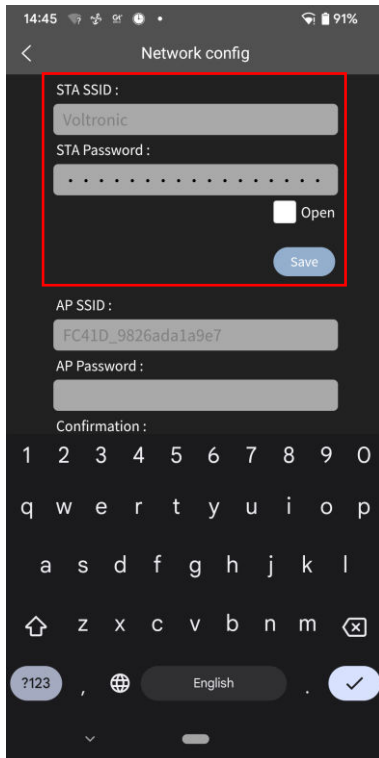

- Enter the Wi-Fi name (AP SSID) and Wi-Fi password (AP Password) of the Wi-Fi module, confirm the password again and click the "Save" button to complete the setting of the Wi-Fi module.

If you check "Open" checkbox, you only need to enter the Wi-Fi name (AP SSID), no need to enter the Wi-Fi password and Confirmation. Then, click the "Save" button to complete the setting.

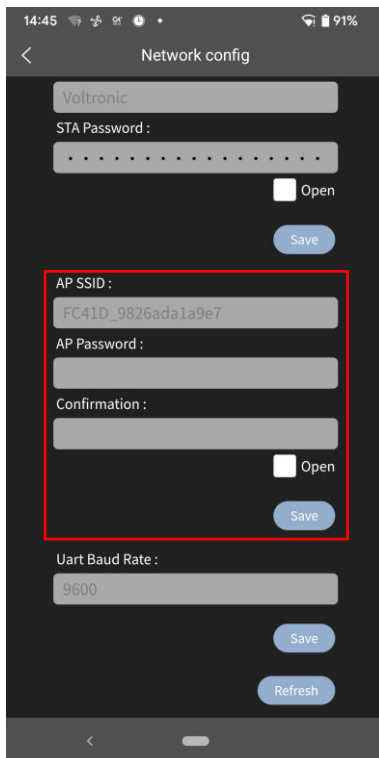

### 2-3. Log-In

- Connect your smart phone to the router.
- Registration at first time.

After fill in user name and password, click the "Register" button to complete the user registration. Once registration is complete, click "Click to log in" or return to the previous page (click the left arrow to return to the login page). Then, enter the registered user name and password to log in.

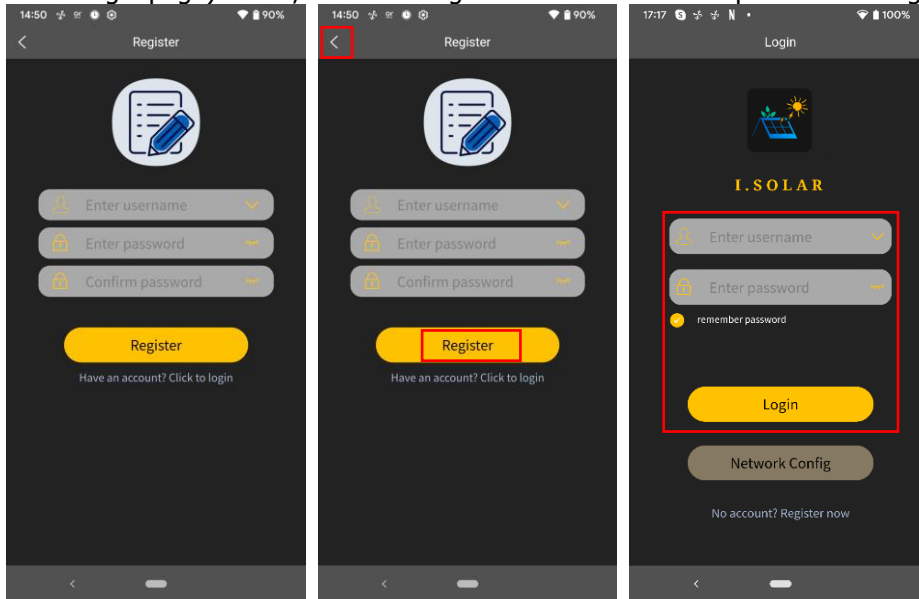

### 2-4. Home Page

- After login, the default Home page will appear.
- Tap the icon (located on the right top) to enter the page to add, delete or rename the device. Input the device serial number to add the device.

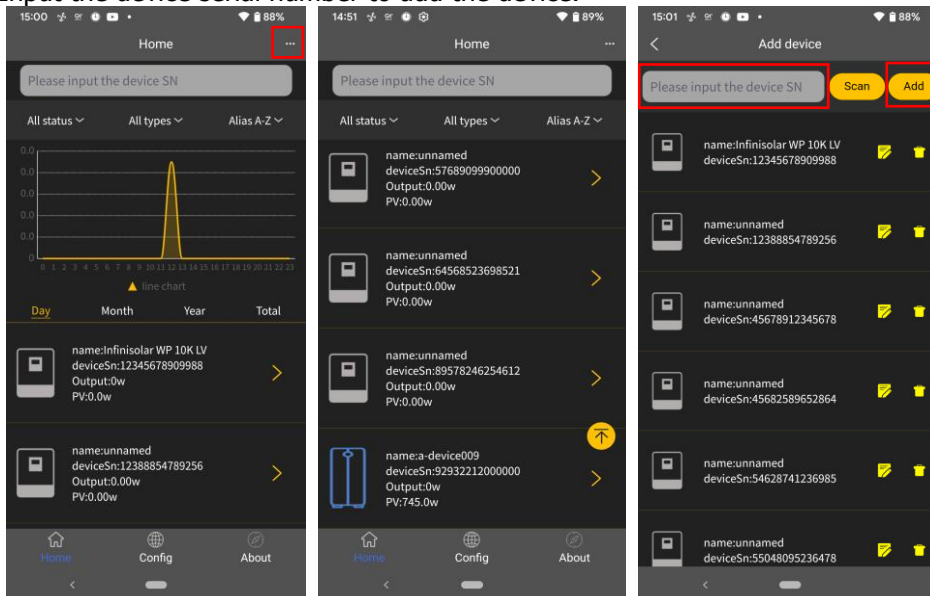



## Rename or delete the device

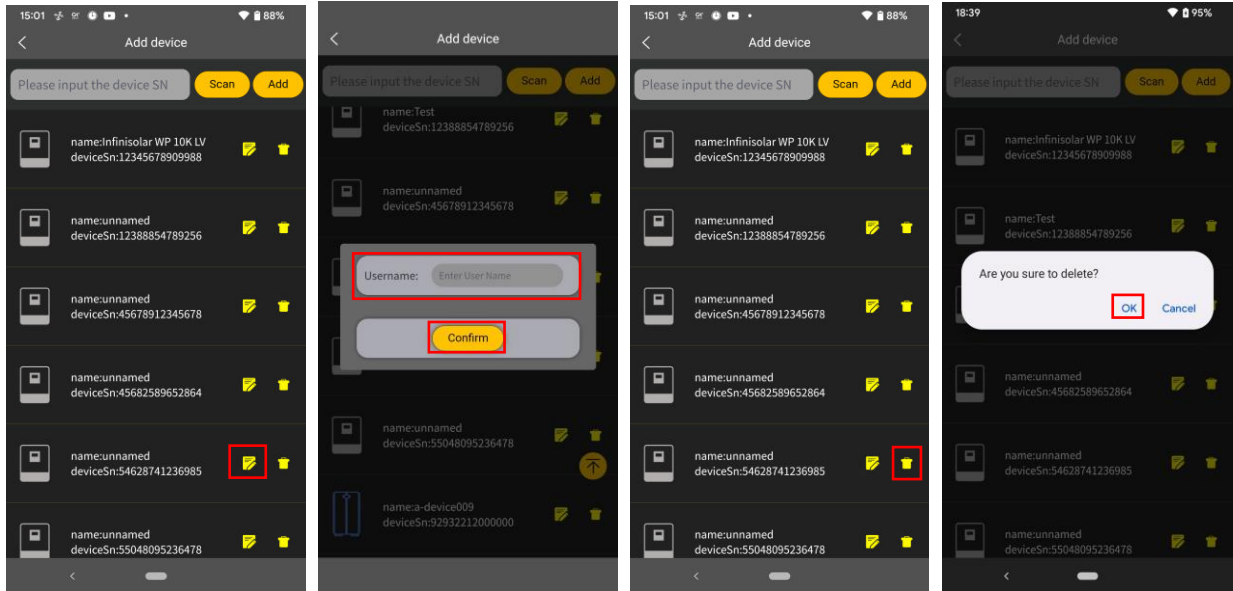

Above is the chart data area:

Day: Click the button to query the hourly power generation data of the current day.

Month: Click the button to query the daily power generation data of the current month.

Year: Click the button to query the monthly power generation data of the current year.

Total: Click the button to query the annual power generation data.

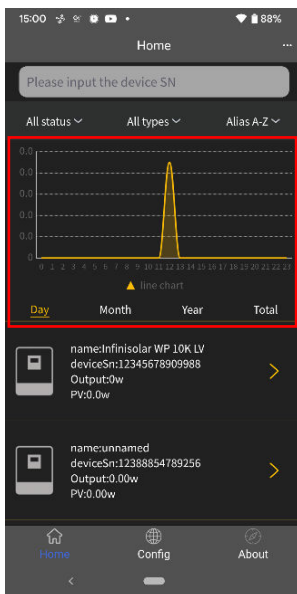

## 2-5. Real-time data

- Main page displays battery information, including SOC, battery temperature, battery voltage, charge or discharge power, charge or discharge current, backup time, battery cell temperature and voltage, grid power, solar power generation in day, month, year, total, and AC output power consumption in day, month, year, total.

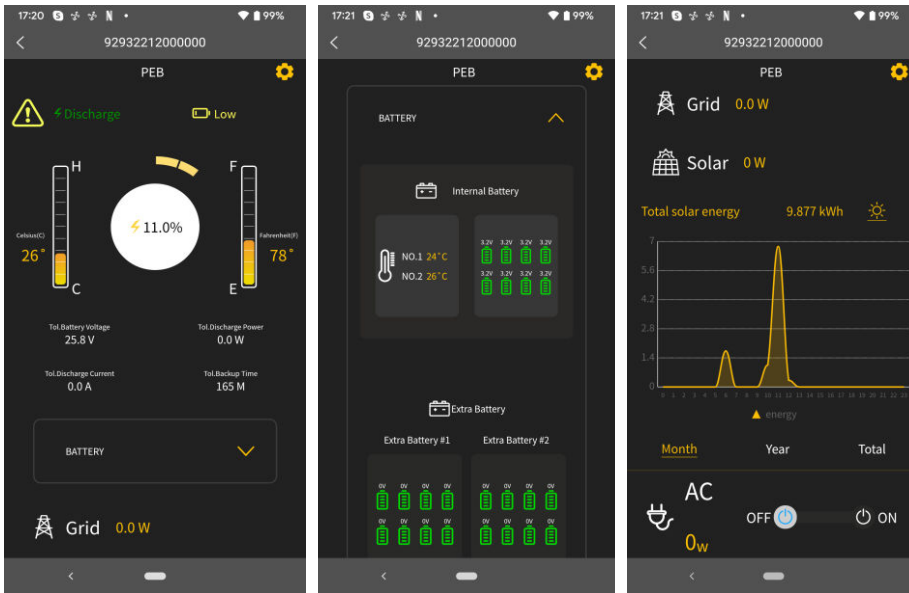

Remote control power on/off and USB charger on/off.

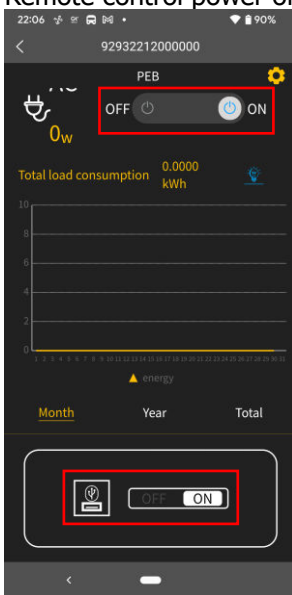

- Tap the icon (located on the right top) to enter the setting page.

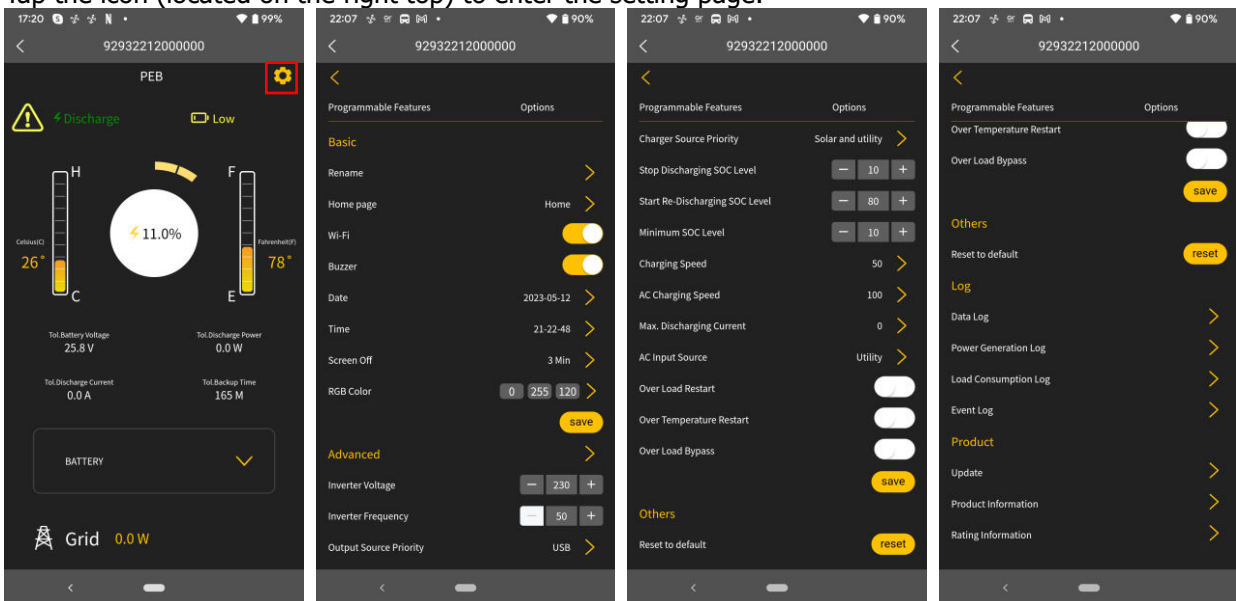

- "Basic" and "Advanced": displays the setting items. Different models, the setting items on the parameter page will be different.

Select the setting and click the "Save" button to change the setting.

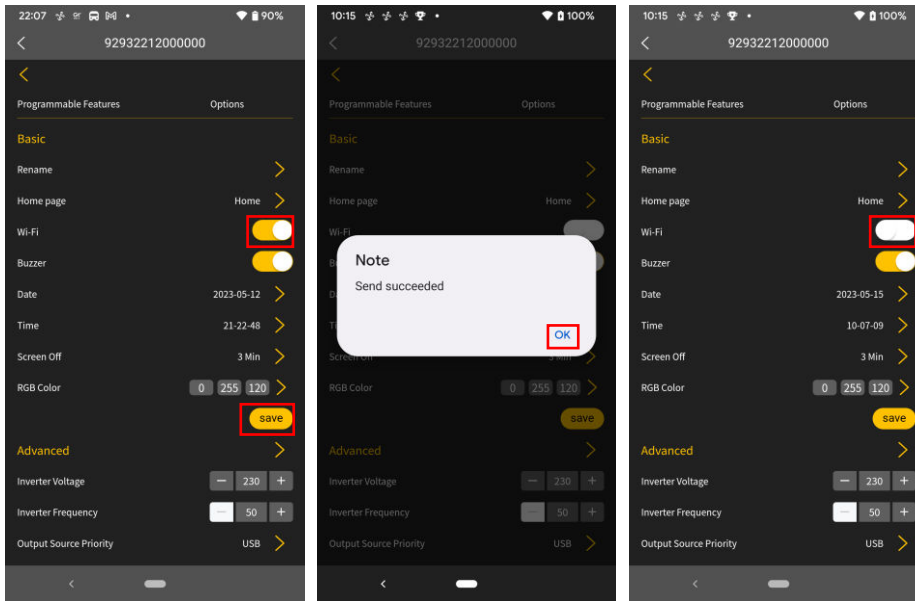

If displays "Please make setting", it means that the setting are the same and there is no need to set it again.

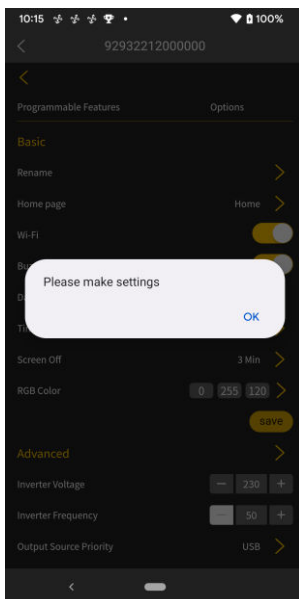

Rename the device.

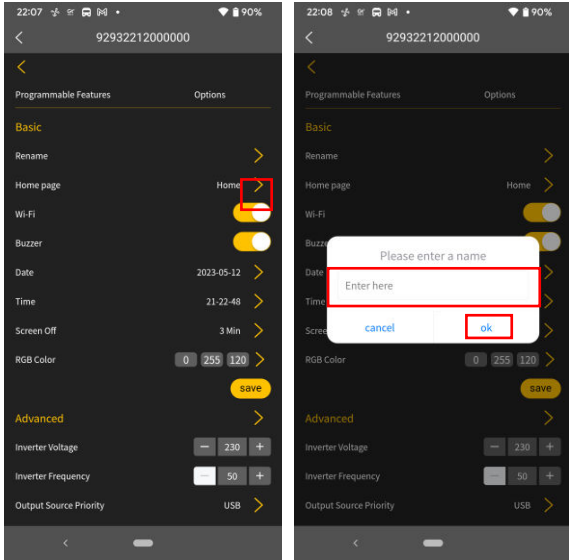

- Log: displays data log, solar power generation log, load consumption log and event.  
Data log: Tap the time, select the date and click the "Browse" button to update log.

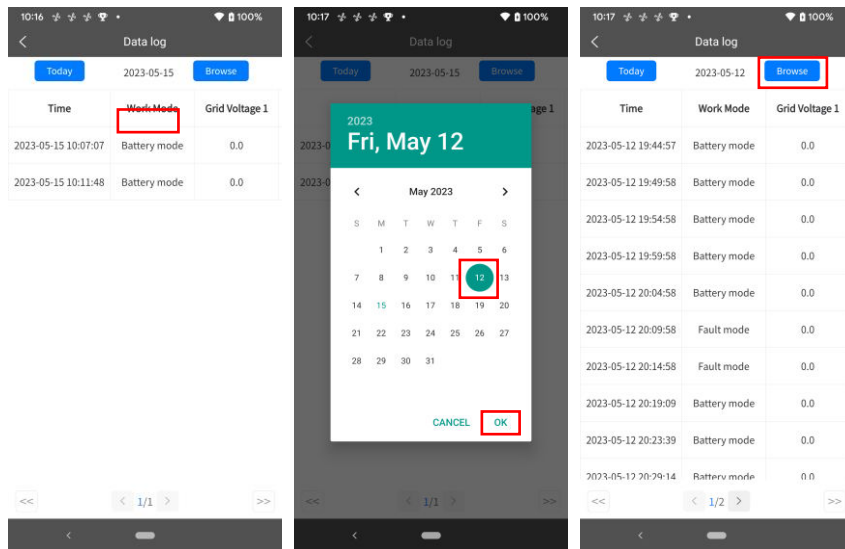

Power Generation Log: Tap the time, select the day, month or year, and click the "Done" button to update log.

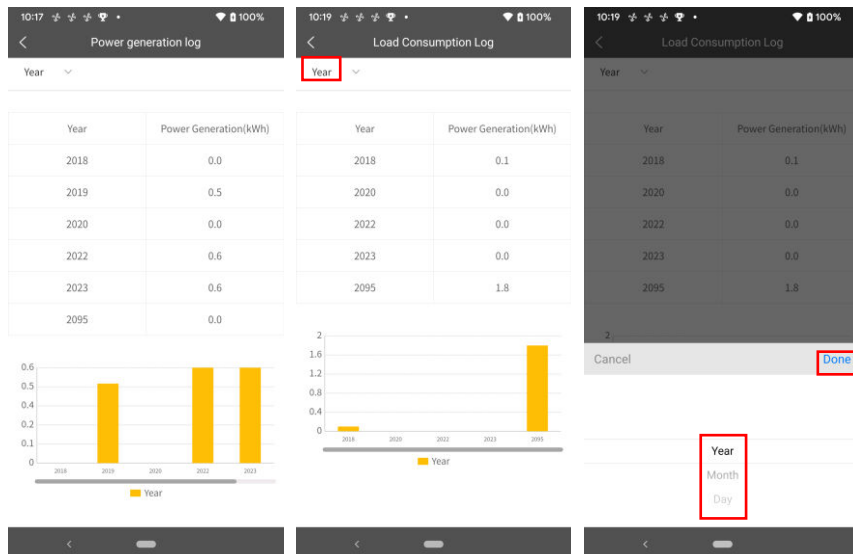

Event log: Tap the time, select the month and click the "Browse" button to update log.

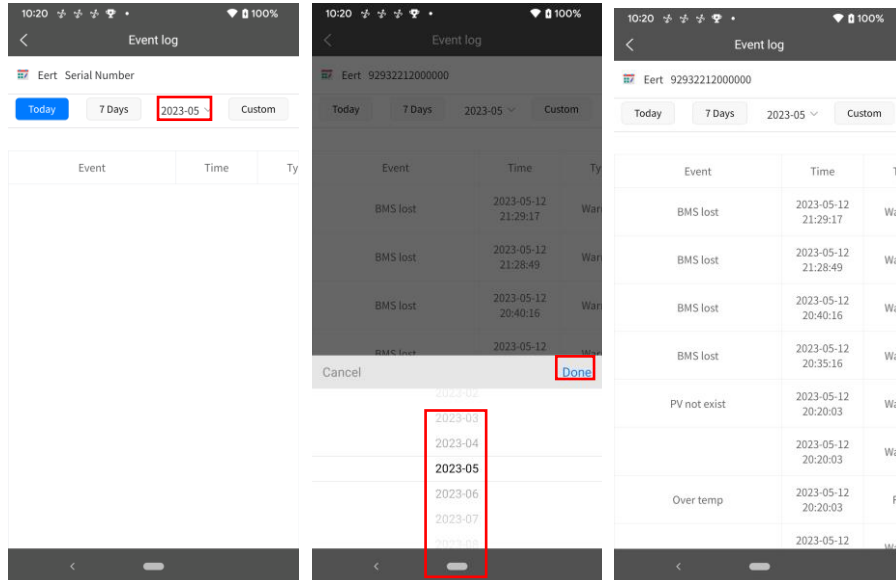

Product: displays product information and rating information.

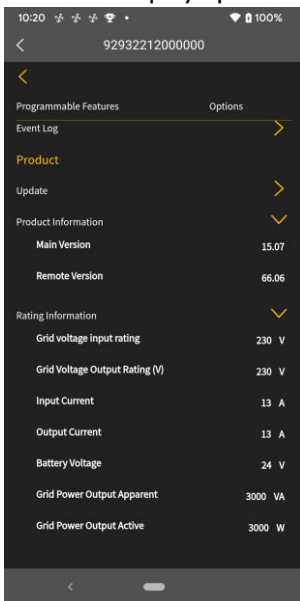

2-6. Configuration: change password and remove account.

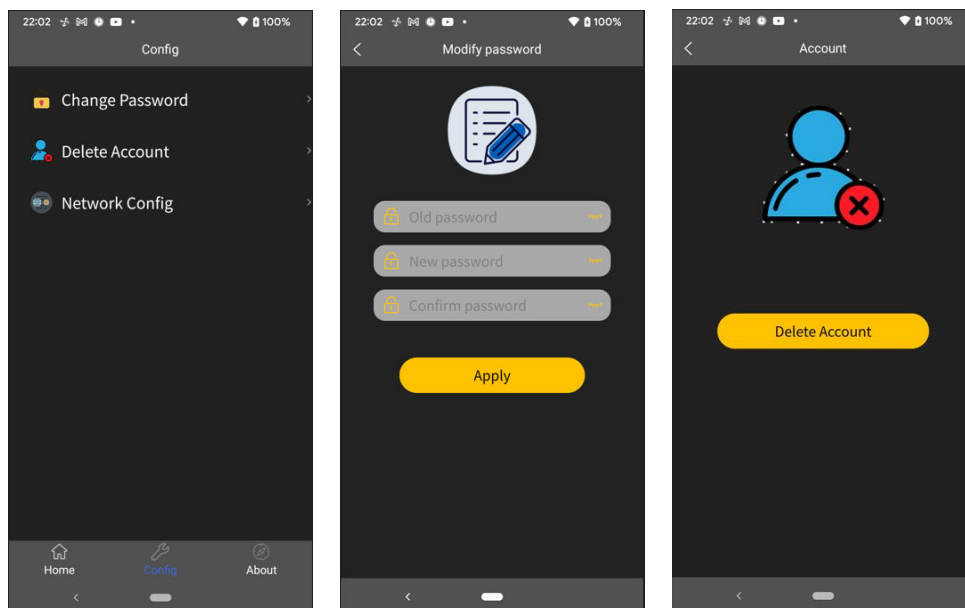

## 2-7.About

